

NAVITOR® Folders



venture pr
a BLUESHEET company

THE PREMIER PROVIDER OF
**Mobile Media &
Marketing Services**

presentation
folders

Your Folders...FASTER
See inside for

24hr
SERVICE options

- 3 **NEW!** poly folders & envelopes
- 4 **NEW!** FasTurn® **24hr** folders
ink & foil
- 5 **NEW!** FasTurn® **48hr** folders
four color process
- 6-7 secured pocket folders
flat & thermography ink
- 8-9 secured pocket folders
four color process
- 10-11 secured pocket folders
foil & embossing
- 12-13 specialty folders
- 14-15 oversized & expandable folders
- 16-17 file folders
- 18-19 mini, document & literature folders
- 20-21 legal folders
- 22-23 tri-fold & vertical folders
- 24 loose pocket folders
- 25 certificate holders
- 26-27 report covers
- 28 multicolor folders
- 29 photo holders & **NEW!** card carriers
- 30-31 stepped & stitched inserts
- 32 Conformer® Expansion Envelopes
- 33 binders & index tabs
- 34 fans
- 35 promotional packaging
- 36 how to order presentation folders
- 37 electronic guidelines
- 38 value-added services
- 39 ink, foil & stock selection

welcome.

Our passion for quality and pursuit of excellence bring:

1 | fast turnaround

24hr service: multiple print options

Navitor® is committed to shipping all folders orders quickly. When you need your folders now - choose from the many folder options that display this **24hr** service symbol

2 | breakthrough printing

trade leader: raised ink folders

At Navitor Folders, we produce Folders in a variety of printing processes including: four color process, foil stamping, blind embossing as well as being one of the elite printers in the world with the capability to imprint folders in thermography (raised ink). Efficiency gains and innovations in technology continue to drive us into new markets and new opportunities.

3 | revolutionary commitment

overruns: your choice - not our policy

Relationships with our valued partners continue to be developed and strengthened through the choice of purchasing overruns and our on-time delivery - over 50% of orders ship prior to the expected ship date. 99% of our orders ship on time.

4 | dependable quality

award winning craftsmanship

Quality remains as the backbone of our company and doesn't go unnoticed. we are frequently recognized by various well respected printing and promotional product associations.

NEW!

Plastic sales have grown rapidly in recent years. The durability of polyethylene and polypropylene protects your material contents under adverse conditions for years to come – making poly the clear cost advantage!



Poly Features
 available as a 9" x 12" Folder or 10" x 13" Conformer® Expansion Envelope (shown)

- **poly colors:** Black, Par Blue, White, Red, Clear Matte
- **standard screen ink colors:** Black, Reflex Blue, Red
- **special screen ink colors** available for an additional charge
- **image size** up to 36 square inches

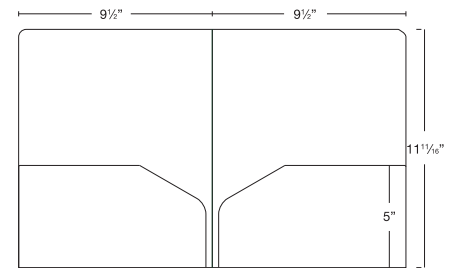

Item Number UF9-FF-2-POLY
 Style FF-2-POLY

Poly Folders price per piece

	smart art code	250	500	1000	2500
blank		\$3.42	2.44	1.88	1.60
1 standard screen color	1S	\$5.00	3.46	2.50	2.03
2 standard screen colors	1S	\$6.59	4.47	3.13	2.46

Poly Envelopes price per piece

	smart art code	250	500	1000	2500
blank		\$4.42	2.92	2.25	1.78
1 standard screen color	1S	\$6.01	3.93	2.87	2.21
2 standard screen colors	1S	\$7.60	4.94	3.50	2.64

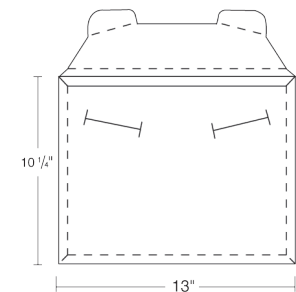

Conformer® Expansion Envelope
 Item Number UF9-QET-POLY
 Style QET-POLY

(T) Prices effective January, 2009

For more information on Smart Art Codes, visit www.smart-artwork.com.

Production time: 4 weeks

FasTurn® 24 hour folders



NEW!

- 1 and 2 color flat ink
- Now up to 1000 quantity

FasTurn® 24 hour features

- available on our most popular style (shown at left) with standard horizontal business card slits centered on right pocket.
- choose one of the following printing options for the front of the folder only:

one flat or thermography ink

image size up to 32 square inches.

two flat or thermography inks

image size up to 32 square inches.

one color foil stamping

image size up to 16 square inches.

24hr SERVICE

- one easy price means no extra charges or setup costs.
- standard ground shipping within the continental U.S. is included in the FasTurn® pricing listed below.

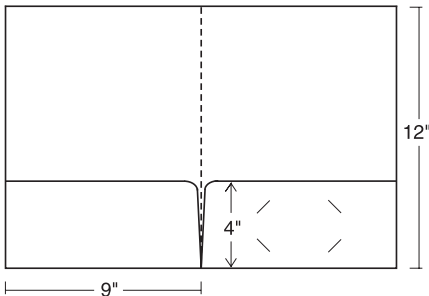

Item Number **UF9-FN-2**
Style FN-2

FasTurn® 24 hour folders

	smart art code	50	100	200	250	500	1000
no imprint		\$137.05	173.60	242.60	274.05	431.40	745.40
1 standard ink (below)	1S	\$158.35	205.05	284.20	321.75	505.50	872.50
2 standard inks (below)	1S	\$205.05	269.00	348.15	384.70	568.40	935.40
1 standard foil color (below)	1S	\$199.95	247.70	326.85	363.40	547.10	914.10

(R) Prices effective January, 2009

For more information on Smart Art Codes, visit www.smart-artwork.com.

Production time: 24 hours

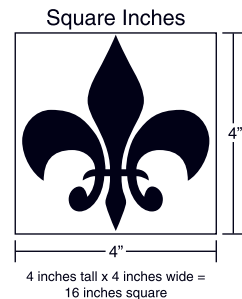

- bleeds are not available with thermography raised ink.
- please indicate item number UF9-FN-2 on your order blank.
- prices based on receiving print ready art.

raised ink colors

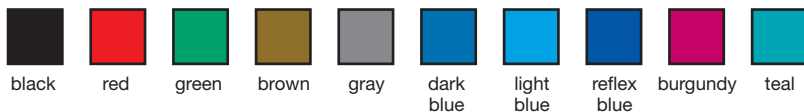

foil colors

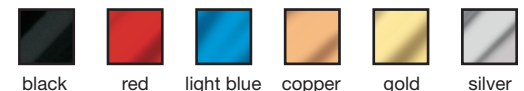

stock selection

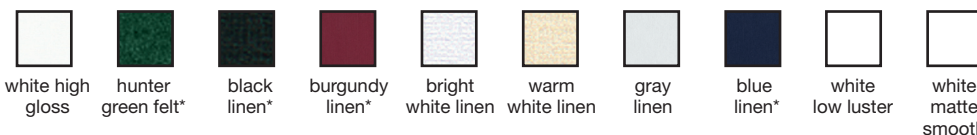

NOTE: Inks, foils and stocks are close representations. Exact color may vary.

* Dark stocks available only with foil stamping.

NEW!

**48hr
SERVICE**

- one easy price means no extra charges or setup costs.
- standard ground shipping within the continental U.S. is included in the FasTurn® pricing listed below.

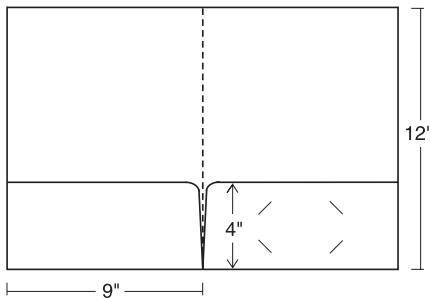

Item Number UF9-FN-2
Style FN-2

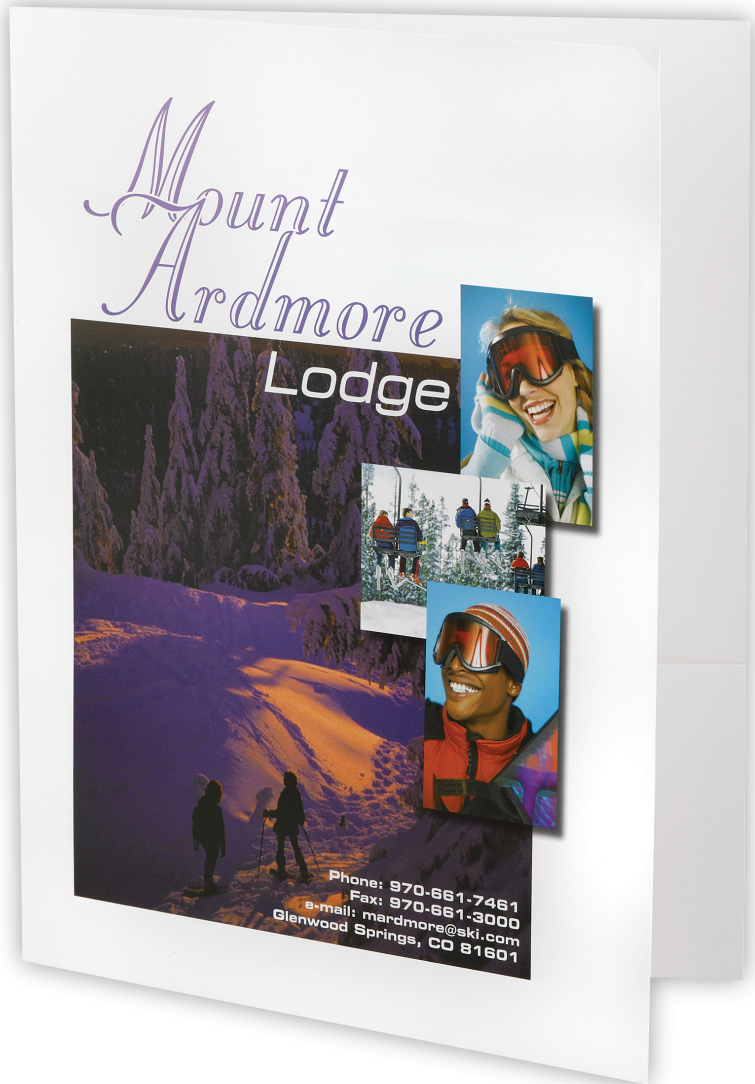

FasTurn® 48 hour features

- available on our most popular style (shown at left) with standard horizontal business card slits centered on right pocket.
- please indicate item number UF9-FN-2 on your order blank.
- prices based on receiving print ready art.
- up to 50% coverage on one side- includes outside and pockets.

FasTurn® 48 hour folders

	smart art code	50	100	200	250	500	1000
four color process	4C	\$316.70	428.35	638.45	737.90	1149.00	1387.50

(R) Prices effective January, 2009

For more information on Smart Art Codes, visit www.smart-artwork.com.

Production time: 48 hours

stock selection



secured pocket folder

flat & thermography ink

secured pocket folders

class 1 stocks	smart art code	50	100	250	500	1000	2000	2500	3000	5000
no imprint 24hr	-	\$172.55	221.30	364.40	560.30	919.60	1486.00	1765.10	1984.35	2859.25
1 standard ink 24hr	1S	\$225.35	293.40	474.05	684.15	1071.85	1687.00	1990.45	2218.85	3131.30
2 standard inks 24hr	1S	\$347.15	415.20	595.85	826.25	1247.45	1927.55	2261.45	2515.25	3511.95

Please note: the above prices are for class 1 stocks. For all other stocks, please add the prices below. If not specified, raised ink will be used. For more information on Smart Art Codes, visit www.smart-artwork.com.

additional stock options (add charges below to top prices)

	50	100	250	500	1000	2000	2500	3000	5000
class 2 stocks	\$29.40	37.25	53.90	72.55	108.80	182.30	218.55	254.80	399.85
class 3 stocks	\$54.90	62.75	80.40	108.80	166.60	280.30	338.10	394.95	623.30
class 4 stocks	\$76.45	88.20	118.60	166.60	259.70	446.90	541.00	634.10	1003.55
class 5 stocks	\$140.15	166.60	228.35	327.35	503.75	841.85	1008.45	1175.05	1818.90

additional options (add charges below to top prices)

	50	100	250	500	1000	2000	2500	3000	5000
Conformer® Expansion Pocket (2 pockets)	\$30.65	37.75	56.55	78.45	118.95	183.95	216.00	240.55	338.70
heavy ink coverage	not available		\$171.90	183.80	207.45	254.85	278.50	302.20	396.95
uv coating	not available		\$171.90	183.80	207.45	254.85	278.50	302.20	396.95
each add'l standard ink color	not available		\$121.80	142.10	175.60	240.55	271.00	296.40	380.65
inside copy (above pockets)	not available		\$118.55	138.75	174.00	236.10	262.00	281.65	360.35
additional foil stamp run*	not available		\$195.20	232.45	306.85	455.60	530.55	604.50	900.80
additional blind emboss run*	not available		\$237.55	257.85	317.00	455.60	530.55	604.50	900.80

(R) Prices effective January, 2009

* price includes up to a 36 square inch die

Production time: 24 hours

standard stock options

class 1

low luster white 10 pt C1S
white vellum 80 lb.
ivory index 110 lb.
tag manila 125 lb.
low luster white 12 pt C1S
bright white linen 80 lb.
warm white linen 80 lb.
yellow wove 65 lb.

class 2

gloss coated white 10 pt. C1S
gray linen 80 lb.
charcoal linen 80 lb.*, ***
white felt 80 lb.
Cougar® opaque smooth white 80 lb.
lively ivory linen 80 lb.
sky blue linen 80 lb.
white laid 80 lb.
gray laid 80 lb.
ivory laid 80 lb.
warm white laid 80 lb.
burgundy linen 80 lb.***
green linen 80 lb.***
blue linen 80 lb.***
black linen 80 lb.***

class 3

tan vellum 80 lb.
ivory vellum 80 lb.
gloss coated white 12 pt. C1S
warm white linen 100 lb.
Cougar® opaque smooth white 100 lb.
hunter green felt 80 lb.***
low luster white 15 pt. C1S
bright white linen 100 lb.
white fiber 80 lb.
low luster white 10 pt. C2S**
low luster white 12 pt. C2S**
warm white smooth 80 lb.

class 4

light green felt 80 lb.
cream fiber 80 lb.
Environment® ultra bright white 80 lb.
gloss coated white 10 pt. C2S**
berry felt 80 lb.***
low luster white 14 pt. C2S**
bronzed felt 80 lb.***
Classic Crest® solar white 80 lb.
Classic Crest® natural white 80 lb.
whitestone laid 80 lb.
silverstone laid 80 lb.
burgundy linen 100 lb.***
gloss coated white 12 pt. C2S**

class 5

gloss coated black 12 pt. C1S***
gloss coated red 12 pt. C1S***
gloss coated burgundy 12 pt. C1S***
gloss coated navy 12 pt. C1S***
gloss coated silver 12 pt. C1S***
blue linen 100 lb.***
ebony felt 80 lb.***
marine felt 80 lb.***
pewter felt 80 lb.***
teal felt 80 lb.***
Classic® linen avon white 80 lb.
red felt 90 lb.***
leatherette persian blue 90 lb.***
leatherette forest green 90 lb.***

* Charcoal Linen is not available in styles A-3, F-3, FM, G, HV, L, M, N, Q, QET, QEZL, QETL, QL, or V

** Coated two sided stock is available with four color process, flat ink, foil stamping and embossing

*** Colored High Gloss and Dark Colored stocks are available with Foil and/or Embossing only.

secured pocket folder

flat & thermography ink

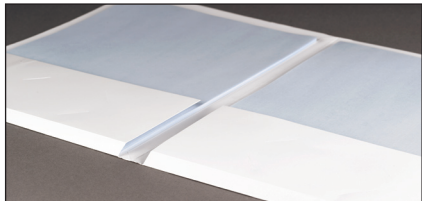

Thicker materials like booklets and catalogs fit perfectly in our roomier Conformer® Expansion Folder Style Q-2. See Additional Options for Expansion Pocket pricing.

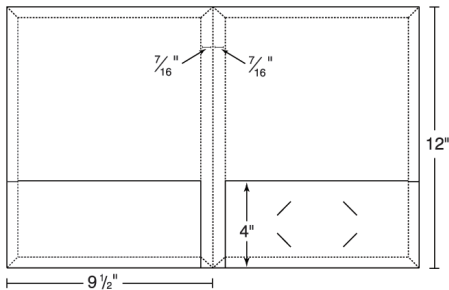

Conformer® Expansion Folder
Item Number UF9-Q-2
 Style Q-2

U.S. patent number is required to print on all Conformer® Expansion Products:
 6,116,651 Conformer® Expansion Folder • 6,227,444 Conformer®
 Expansion Envelope. Conformer® is a registered trademark of
CONFORMER EXPANSION PRODUCTS, INC.

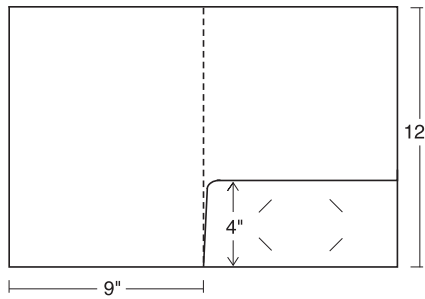

Item Number UF9-F-1
 Style F-1

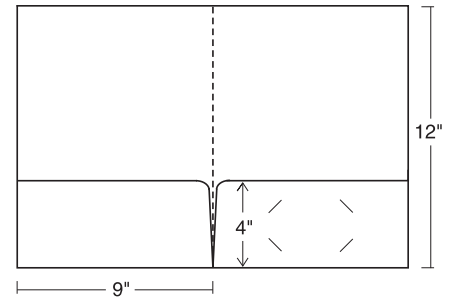

Item Number UF9-F-2
 Style F-2

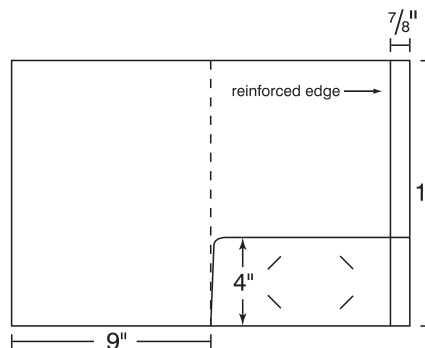

Item Number UF9-B-1
 Style B-1

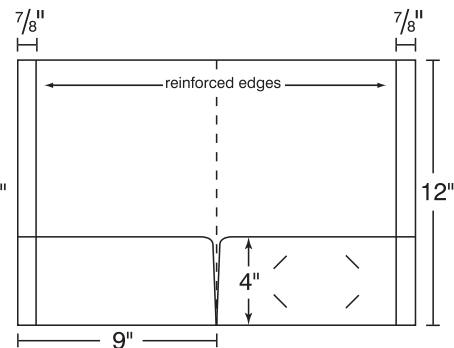

Item Number UF9-B-2
 Style B-2

secured pocket folder

four color process

secured pocket folders

class 1 stocks	smart art code	50	100	250	500	1000	2000	2500	3000	5000
four color process	4C	\$803.90	871.95	1052.60	1283.00	1704.20	2384.30	2718.20	2972.00	3968.70

Please note: the above prices are for class 1 stocks. For all other stocks, please add the prices below. If not specified, raised ink will be used. For more information on Smart Art Codes, visit www.smart-artwork.com.

additional stock options (add charges below to top prices)

	50	100	250	500	1000	2000	2500	3000	5000
class 2 stocks	\$29.40	37.25	53.90	72.55	108.80	182.30	218.55	254.80	399.85
class 3 stocks	\$54.90	62.75	80.40	108.80	166.60	280.30	338.10	394.95	623.30
class 4 stocks	\$76.45	88.20	118.60	166.60	259.70	446.90	541.00	634.10	1003.55
class 5 stocks	\$140.15	166.60	228.35	327.35	503.75	841.85	1008.45	1175.05	1818.90

additional options (add charges below to top prices)

	50	100	250	500	1000	2000	2500	3000	5000
Conformer® Expansion Pocket (2 pockets)	\$30.65	37.75	56.55	78.45	118.95	183.95	216.00	240.55	338.70
heavy ink coverage	not available		\$171.90	183.80	207.45	254.85	278.50	302.20	396.95
uv coating	not available		\$171.90	183.80	207.45	254.85	278.50	302.20	396.95
each add'l standard ink color	not available		\$121.80	142.10	175.60	240.55	271.00	296.40	380.65
inside copy (above pockets)	not available		\$118.55	138.75	174.00	236.10	262.00	281.65	360.35
additional foil stamp run*	not available		\$195.20	232.45	306.85	455.60	530.55	604.50	900.80
additional blind emboss run*	not available		\$237.55	257.85	317.00	455.60	530.55	604.50	900.80

(R) Prices effective January, 2009

Production time: 5 working days

* price includes up to a 36 square inch die

standard stock options

class 1

low luster white 10 pt C1S
white vellum 80 lb.
ivory index 110 lb.
tag manila 125 lb.
low luster white 12 pt C1S
bright white linen 80 lb.
warm white linen 80 lb.
yellow wove 65 lb.

class 2

gloss coated white 10 pt. C1S
gray linen 80 lb.
charcoal linen 80 lb.**, ***
white felt 80 lb.
Cougar® opaque smooth white 80 lb.
lively ivory linen 80 lb.
sky blue linen 80 lb.
white laid 80 lb.
gray laid 80 lb.
ivory laid 80 lb.
warm white laid 80 lb.
burgundy linen 80 lb.***
green linen 80 lb.***
blue linen 80 lb.***
black linen 80 lb.***

class 3

tan vellum 80 lb.
ivory vellum 80 lb.
gloss coated white 12 pt. C1S
warm white linen 100 lb.
Cougar® opaque smooth white 100 lb.
hunter green felt 80 lb.***
low luster white 15 pt. C1S
bright white linen 100 lb.
white fiber 80 lb.
low luster white 10 pt. C2S**
low luster white 12 pt. C2S**
warm white smooth 80 lb.

class 4

light green felt 80 lb.
cream fiber 80 lb.
Environment® ultra bright white 80 lb.
gloss coated white 10 pt. C2S**
berry felt 80 lb.***
low luster white 14 pt. C2S**
bronzed felt 80 lb.***
Classic Crest® solar white 80 lb.
Classic Crest® natural white 80 lb.
whitestone laid 80 lb.
silverstone laid 80 lb.
burgundy linen 100 lb.***
gloss coated white 12 pt. C2S**

class 5

gloss coated black 12 pt. C1S***
gloss coated red 12 pt. C1S***
gloss coated burgundy 12 pt. C1S***
gloss coated navy 12 pt. C1S***
gloss coated silver 12 pt. C1S***
blue linen 100 lb.***
ebony felt 80 lb.***
marine felt 80 lb.***
pewter felt 80 lb.***
teal felt 80 lb.***
Classic® linen avon white 80 lb.
red felt 90 lb.***
leatherette persian blue 90 lb.***
leatherette forest green 90 lb.***

* Charcoal Linen is not available in styles A-3, F-3, FM, G, HV, L, M, N, Q, QET, QEZL, QETL, QEZL, QL, or V

** Coated two sided stock is available with four color process, flat ink, foil stamping and embossing

*** Colored High Gloss and Dark Colored stocks are available with Foil and/or Embossing only.

secured pocket folder

four color process

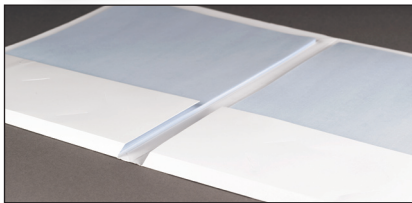
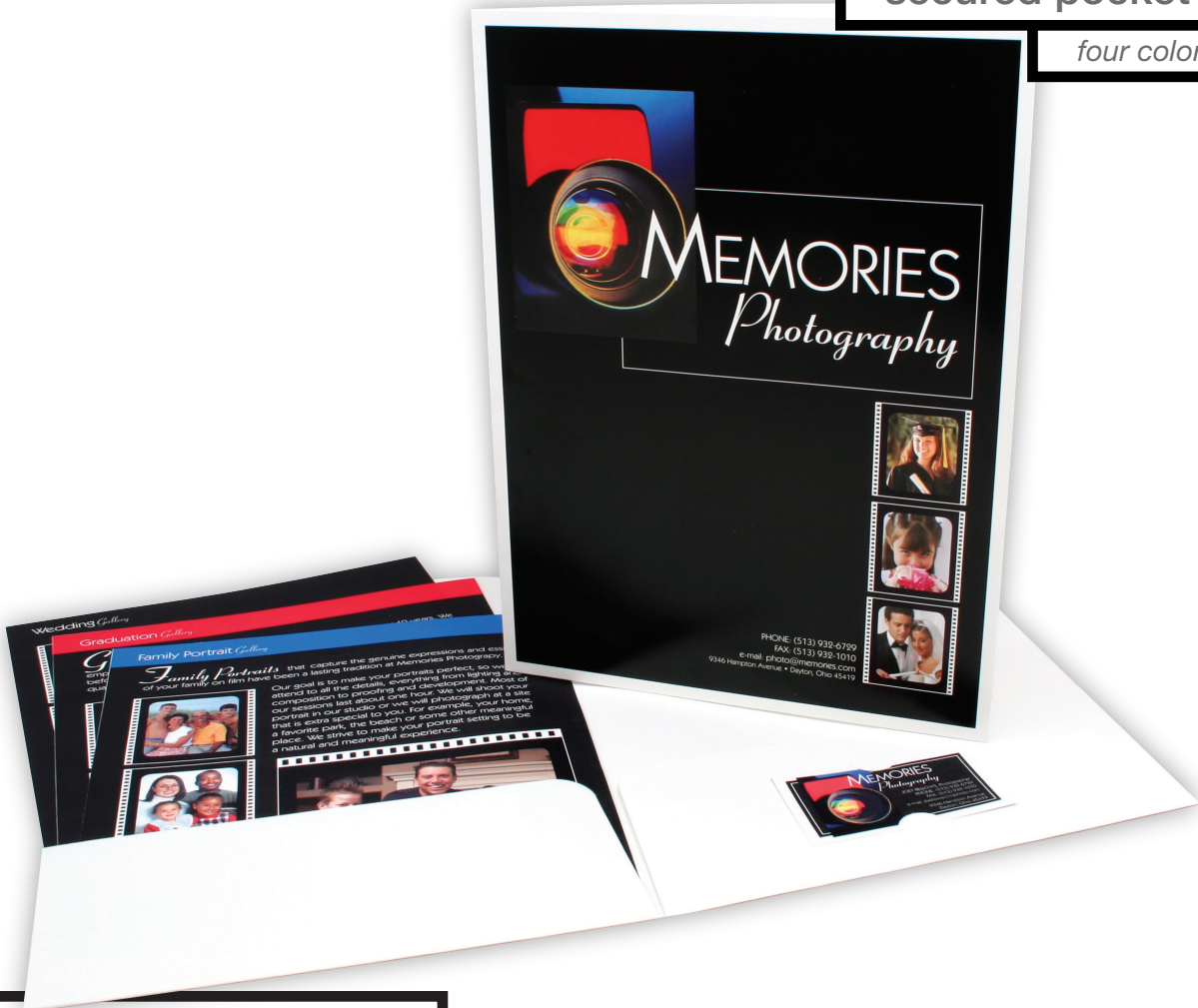

Thicker materials like booklets and catalogs fit perfectly in our roomier Conformer® Expansion Folder Style Q-2. See Additional Options for Expansion Pocket pricing.

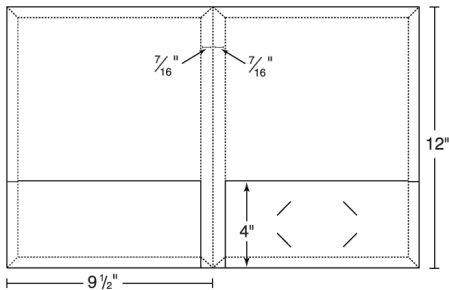

Conformer® Expansion Folder
Item Number UF9-Q-2
 Style Q-2

U.S. patent number is required to print on all Conformer® Expansion Products:
 6,116,651 Conformer® Expansion Folder • 6,227,444 Conformer®
 Expansion Envelope. Conformer® is a registered trademark of
CONFORMER EXPANSION PRODUCTS, INC.

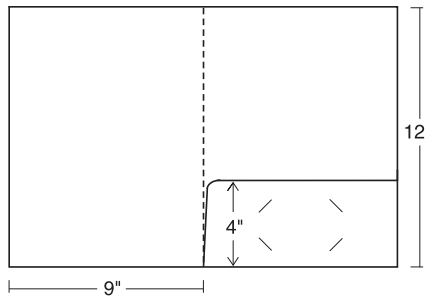

Item Number UF9-F-1
 Style F-1

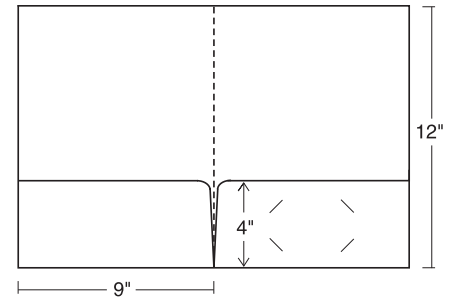

Item Number UF9-F-2
 Style F-2

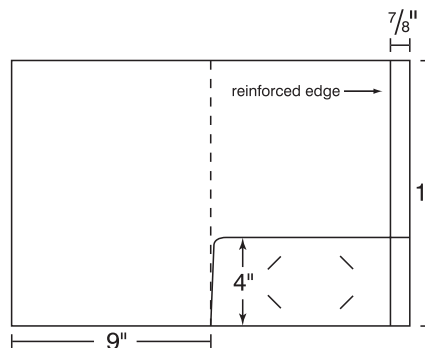

Item Number UF9-B-1
 Style B-1

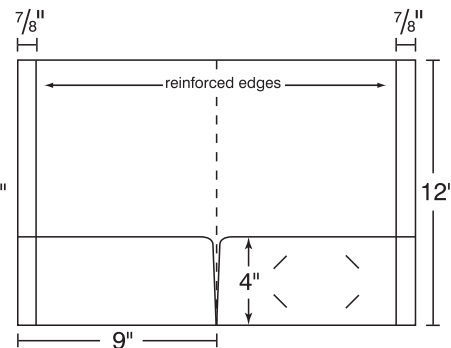

Item Number UF9-B-2
 Style B-2

secured pocket folder

foil stamping & embossing

secured pocket folders

class 1 stocks	smart art code	50	100	250	500	1000	2000	2500	3000	5000
1 standard foil stamp* 24hr	1S	\$306.55	377.65	565.40	784.65	1189.60	1839.25	2160.00	2405.65	3387.10
blind embossing*	1X	\$365.45	431.45	605.00	802.95	1199.75	1839.25	2160.00	2405.65	3387.10

Please note: the above prices are for class 1 stocks. For all other stocks, please add the prices below. If not specified, raised ink will be used. For more information on Smart Art Codes, visit www.smart-artwork.com.

additional stock options (add charges below to top prices)

	50	100	250	500	1000	2000	2500	3000	5000
class 2 stocks	\$29.40	37.25	53.90	72.55	108.80	182.30	218.55	254.80	399.85
class 3 stocks	\$54.90	62.75	80.40	108.80	166.60	280.30	338.10	394.95	623.30
class 4 stocks	\$76.45	88.20	118.60	166.60	259.70	446.90	541.00	634.10	1003.55
class 5 stocks	\$140.15	166.60	228.35	327.35	503.75	841.85	1008.45	1175.05	1818.90

additional options (add charges below to top prices)

	50	100	250	500	1000	2000	2500	3000	5000
Conformer® Expansion Pocket (2 pockets)	\$30.65	37.75	56.55	78.45	118.95	183.95	216.00	240.55	338.70
heavy ink coverage	not available		\$171.90	183.80	207.45	254.85	278.50	302.20	396.95
uv coating	not available		\$171.90	183.80	207.45	254.85	278.50	302.20	396.95
each add'l standard ink color	not available		\$121.80	142.10	175.60	240.55	271.00	296.40	380.65
inside copy (above pockets)	not available		\$118.55	138.75	174.00	236.10	262.00	281.65	360.35
additional foil stamp run*	not available		\$195.20	232.45	306.85	455.60	530.55	604.50	900.80
additional blind emboss run*	not available		\$237.55	257.85	317.00	455.60	530.55	604.50	900.80

(R) Prices effective January, 2009
* price includes up to a 36 square inch die

Production time: 24 hours (foil stamping)
3 working days (embossing)

standard stock options

class 1

low luster white 10 pt C1S
white vellum 80 lb.
ivory index 110 lb.
tag manila 125 lb.
low luster white 12 pt C1S
bright white linen 80 lb.
warm white linen 80 lb.
yellow wove 65 lb.

class 2

gloss coated white 10 pt. C1S
gray linen 80 lb.
charcoal linen 80 lb.*, ***
white felt 80 lb.
Cougar® opaque smooth white 80 lb.
lively ivory linen 80 lb.
sky blue linen 80 lb.
white laid 80 lb.
gray laid 80 lb.
ivory laid 80 lb.
warm white laid 80 lb.
burgundy linen 80 lb.***
green linen 80 lb.***
blue linen 80 lb.***
black linen 80 lb.***

class 3

tan vellum 80 lb.
ivory vellum 80 lb.
gloss coated white 12 pt. C1S
warm white linen 100 lb.
Cougar® opaque smooth white 100 lb.
hunter green felt 80 lb.***
low luster white 15 pt. C1S
bright white linen 100 lb.
white fiber 80 lb.
low luster white 10 pt. C2S**
low luster white 12 pt. C2S**
warm white smooth 80 lb.

class 4

light green felt 80 lb.
cream fiber 80 lb.
Environment® ultra bright white 80 lb.
gloss coated white 10 pt. C2S**
berry felt 80 lb.***
low luster white 14 pt. C2S**
bronzed felt 80 lb.***
Classic Crest® solar white 80 lb.
Classic Crest® natural white 80 lb.
whitestone laid 80 lb.
silverstone laid 80 lb.
burgundy linen 100 lb.***
gloss coated white 12 pt. C2S**

class 5

gloss coated black 12 pt. C1S***
gloss coated red 12 pt. C1S***
gloss coated burgundy 12 pt. C1S***
gloss coated navy 12 pt. C1S***
gloss coated silver 12 pt. C1S***
blue linen 100 lb.***
ebony felt 80 lb.***
marine felt 80 lb.***
pewter felt 80 lb.***
teal felt 80 lb.***
Classic® linen avon white 80 lb.
red felt 90 lb.***
leatherette persian blue 90 lb.***
leatherette forest green 90 lb.***

* Charcoal Linen is not available in styles A-3, F-3, FM, G, HV, L, M, N, Q, QET, QEZ, QETL, QEZL, QL, or V
** Coated two sided stock is available with four color process, flat ink, foil stamping and embossing
*** Colored High Gloss and Dark Colored stocks are available with Foil and/or Embossing only.

secured pocket folder

foil stamping & embossing

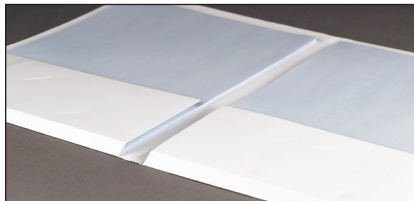

Thicker materials like booklets and catalogs fit perfectly in our roomier Conformer® Expansion Folder Style Q-2. See Additional Options for Expansion Pocket pricing.

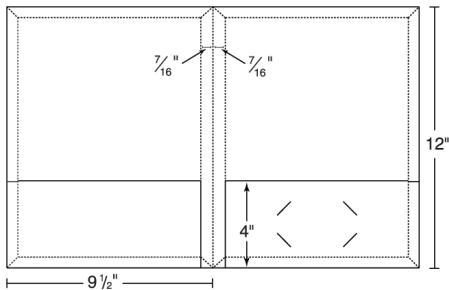

Conformer® Expansion Folder
Item Number UF9-Q-2
Style Q-2

U.S. patent number is required to print on all Conformer® Expansion Products:
6,116,651 Conformer® Expansion Folder • 6,227,444 Conformer® Expansion Envelope. Conformer® is a registered trademark of CONFORMER EXPANSION PRODUCTS, INC.

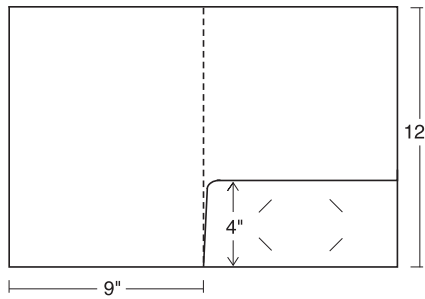

Item Number UF9-F-1
Style F-1

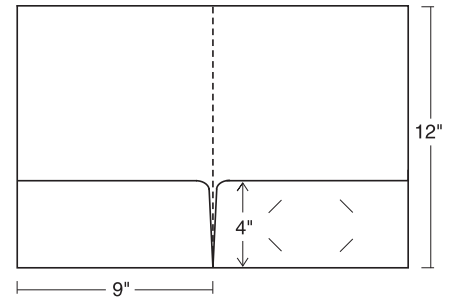

Item Number UF9-F-2
Style F-2

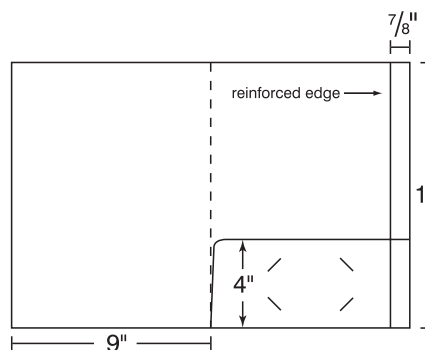

Item Number UF9-B-1
Style B-1

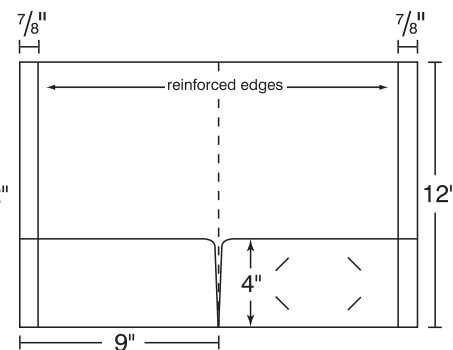

Item Number UF9-B-2
Style B-2

specialty folders

specialty folders

class 1 stocks	smart art code	50	100	250	500	1000	2000	2500	3000	5000
no imprint 24hr	-	\$172.55	221.30	364.40	560.30	919.60	1486.00	1765.10	1984.35	2859.25
1 standard ink 24hr	1S	\$225.35	293.40	474.05	684.15	1071.85	1687.00	1990.45	2218.85	3131.30
2 standard inks 24hr	1S	\$347.15	415.20	595.85	826.25	1247.45	1927.55	2261.45	2515.25	3511.95
1 standard foil stamp* 24hr	1S	\$306.55	377.65	565.40	784.65	1189.60	1839.25	2160.00	2405.65	3387.10
blind embossing*	1X	\$365.45	431.45	605.00	802.95	1199.75	1839.25	2160.00	2405.65	3387.10
four color process	4C	\$803.90	871.95	1052.60	1283.00	1704.20	2384.30	2718.20	2972.00	3968.70

Please note: the above prices are for class 1 stocks. For all other stocks, please add the prices below. If not specified, raised ink will be used. For more information on Smart Art Codes, visit www.smart-artwork.com.

additional stock options (add charges below to top prices)

	50	100	250	500	1000	2000	2500	3000	5000
class 2 stocks	\$29.40	37.25	53.90	72.55	108.80	182.30	218.55	254.80	399.85
class 3 stocks	\$54.90	62.75	80.40	108.80	166.60	280.30	338.10	394.95	623.30
class 4 stocks	\$76.45	88.20	118.60	166.60	259.70	446.90	541.00	634.10	1003.55
class 5 stocks	\$140.15	166.60	228.35	327.35	503.75	841.85	1008.45	1175.05	1818.90

additional options (add charges below to top prices)

	50	100	250	500	1000	2000	2500	3000	5000
heavy ink coverage	not available		\$171.90	183.80	207.45	254.85	278.50	302.20	396.95
uv coating	not available		\$171.90	183.80	207.45	254.85	278.50	302.20	396.95
each add'l standard ink color	not available		\$121.80	142.10	175.60	240.55	271.00	296.40	380.65
inside copy (above pockets)	not available		\$118.55	138.75	174.00	236.10	262.00	281.65	360.35
additional foil stamp run*	not available		\$195.20	232.45	306.85	455.60	530.55	604.50	900.80
additional blind emboss run*	not available		\$237.55	257.85	317.00	455.60	530.55	604.50	900.80

(R) Prices effective January, 2009

* price includes up to a 36 square inch die

Production time: 24 hours (ink & foil stamping),

3 working days (embossing), 5 working days (four color process)

standard stock options

class 1

low luster white 10 pt C1S
white vellum 80 lb.
ivory index 110 lb.
tag manila 125 lb.
low luster white 12 pt C1S
bright white linen 80 lb.
warm white linen 80 lb.
yellow wove 65 lb.

class 2

gloss coated white 10 pt. C1S
gray linen 80 lb.
charcoal linen 80 lb.**, ***
white felt 80 lb.
Cougar® opaque smooth white 80 lb.
lively ivory linen 80 lb.
sky blue linen 80 lb.
white laid 80 lb.
gray laid 80 lb.
ivory laid 80 lb.
warm white laid 80 lb.
burgundy linen 80 lb.***
green linen 80 lb.***
blue linen 80 lb.***
black linen 80 lb.***

class 3

tan vellum 80 lb.
ivory vellum 80 lb.
gloss coated white 12 pt. C1S
warm white linen 100 lb.
Cougar® opaque smooth white 100 lb.
hunter green felt 80 lb.***
low luster white 15 pt. C1S
bright white linen 100 lb.
white fiber 80 lb.
low luster white 10 pt. C2S**
low luster white 12 pt. C2S**
warm white smooth 80 lb.

class 4

light green felt 80 lb.
cream fiber 80 lb.
Environment® ultra bright white 80 lb.
gloss coated white 10 pt. C2S**
berry felt 80 lb.***
low luster white 14 pt. C2S**
bronzed felt 80 lb.***
Classic Crest® solar white 80 lb.
Classic Crest® natural white 80 lb.
whitestone laid 80 lb.
silverstone laid 80 lb.
burgundy linen 100 lb.***
gloss coated white 12 pt. C2S**

class 5

gloss coated black 12 pt. C1S***
gloss coated red 12 pt. C1S***
gloss coated burgundy 12 pt. C1S***
gloss coated navy 12 pt. C1S***
gloss coated silver 12 pt. C1S***
blue linen 100 lb.***
ebony felt 80 lb.***
marine felt 80 lb.***
pewter felt 80 lb.***
teal felt 80 lb.***
Classic® linen avon white 80 lb.
red felt 90 lb.***
leatherette persian blue 90 lb.***
leatherette forest green 90 lb.***

* Charcoal Linen is not available in styles A-3, F-3, FM, G, HV, L, M, N, Q, QET, QEZ, QETL, QEZL, QL, or V

** Coated two sided stock is available with four color process, flat ink, foil stamping and embossing

*** Colored High Gloss and Dark Colored stocks are available with Foil and/or Embossing only.

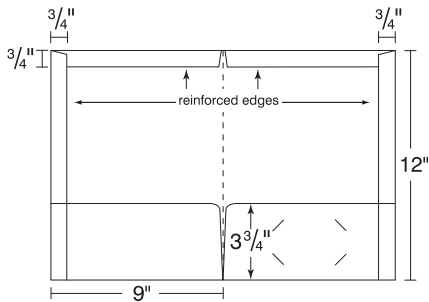

Item Number UF9-TR-2
Style TR-2

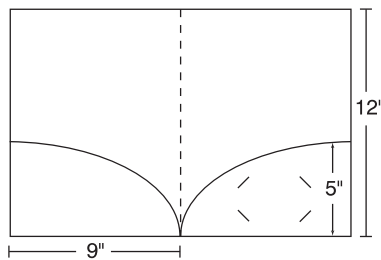

Item Number UF9-N-1 (1 pocket)
Style N-1
Item Number UF9-N-2 (2 pockets)
Style N-2

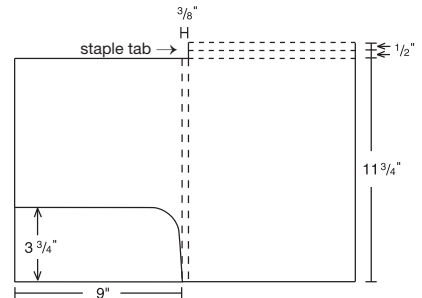

Item Number UF9-BF8
Style BF8

oversized & expandable folders

oversized & expandable folders

class 1 stocks	smart art code	50	100	250	500	1000	2000	2500	3000	5000
no imprint 24hr	-	\$172.55	221.30	364.40	560.30	919.60	1486.00	1765.10	1984.35	2859.25
1 standard ink 24hr	1S	\$225.35	293.40	474.05	684.15	1071.85	1687.00	1990.45	2218.85	3131.30
2 standard inks 24hr	1S	\$347.15	415.20	595.85	826.25	1247.45	1927.55	2261.45	2515.25	3511.95
1 standard foil stamp* 24hr	1S	\$306.55	377.65	565.40	784.65	1189.60	1839.25	2160.00	2405.65	3387.10
blind embossing*	1X	\$365.45	431.45	605.00	802.95	1199.75	1839.25	2160.00	2405.65	3387.10
four color process	4C	\$803.90	871.95	1052.60	1283.00	1704.20	2384.30	2718.20	2972.00	3968.70

Please note: the above prices are for class 1 stocks. For all other stocks, please add the prices below. If not specified, raised ink will be used. For more information on Smart Art Codes, visit www.smart-artwork.com.

additional stock options (add charges below to top prices)

	50	100	250	500	1000	2000	2500	3000	5000
class 2 stocks	\$29.40	37.25	53.90	72.55	108.80	182.30	218.55	254.80	399.85
class 3 stocks	\$54.90	62.75	80.40	108.80	166.60	280.30	338.10	394.95	623.30
class 4 stocks	\$76.45	88.20	118.60	166.60	259.70	446.90	541.00	634.10	1003.55
class 5 stocks	\$140.15	166.60	228.35	327.35	503.75	841.85	1008.45	1175.05	1818.90

additional options (add charges below to top prices)

	50	100	250	500	1000	2000	2500	3000	5000
heavy ink coverage	not available		\$171.90	183.80	207.45	254.85	278.50	302.20	396.95
uv coating	not available		\$171.90	183.80	207.45	254.85	278.50	302.20	396.95
each add'l standard ink color	not available		\$121.80	142.10	175.60	240.55	271.00	296.40	380.65
inside copy (above pockets)	not available		\$118.55	138.75	174.00	236.10	262.00	281.65	360.35
additional foil stamp run*	not available		\$195.20	232.45	306.85	455.60	530.55	604.50	900.80
additional blind emboss run*	not available		\$237.55	257.85	317.00	455.60	530.55	604.50	900.80

(R) Prices effective January, 2009

* price includes up to a 36 square inch die

Production time: 24 hours (ink & foil stamping),

3 working days (embossing), 5 working days (four color process)

standard stock options

class 1

low luster white 10 pt C1S
white vellum 80 lb.
ivory index 110 lb.
tag manila 125 lb.
low luster white 12 pt C1S
bright white linen 80 lb.
warm white linen 80 lb.
yellow wove 65 lb.

class 2

gloss coated white 10 pt. C1S
gray linen 80 lb.
charcoal linen 80 lb.*, ***
white felt 80 lb.
Cougar® opaque smooth white 80 lb.
lively ivory linen 80 lb.
sky blue linen 80 lb.
white laid 80 lb.
gray laid 80 lb.
ivory laid 80 lb.
warm white laid 80 lb.
burgundy linen 80 lb.***
green linen 80 lb.***
blue linen 80 lb.***
black linen 80 lb.***

class 3

tan vellum 80 lb.
ivory vellum 80 lb.
gloss coated white 12 pt. C1S
warm white linen 100 lb.
Cougar® opaque smooth white 100 lb.
hunter green felt 80 lb.***
low luster white 15 pt. C1S
bright white linen 100 lb.
white fiber 80 lb.
low luster white 10 pt. C2S**
low luster white 12 pt. C2S**
warm white smooth 80 lb.

class 4

light green felt 80 lb.
cream fiber 80 lb.
Environment® ultra bright white 80 lb.
gloss coated white 10 pt. C2S**
berry felt 80 lb.***
low luster white 14 pt. C2S**
bronzed felt 80 lb.***
Classic Crest® solar white 80 lb.
Classic Crest® natural white 80 lb.
whitestone laid 80 lb.
silverstone laid 80 lb.
burgundy linen 100 lb.***
gloss coated white 12 pt. C2S**

class 5

gloss coated black 12 pt. C1S***
gloss coated red 12 pt. C1S***
gloss coated burgundy 12 pt. C1S***
gloss coated navy 12 pt. C1S***
gloss coated silver 12 pt. C1S***
blue linen 100 lb.***
ebony felt 80 lb.***
marine felt 80 lb.***
pewter felt 80 lb.***
teal felt 80 lb.***
Classic® linen avon white 80 lb.
red felt 90 lb.***
leatherette persian blue 90 lb.***
leatherette forest green 90 lb.***

* Charcoal Linen is not available in styles A-3, F-3, FM, G, HV, L, M, N, Q, QET, QEZ, QETL, QEZL, QL, or V

** Coated two sided stock is available with four color process, flat ink, foil stamping and embossing

*** Colored High Gloss and Dark Colored stocks are available with Foil and/or Embossing only.

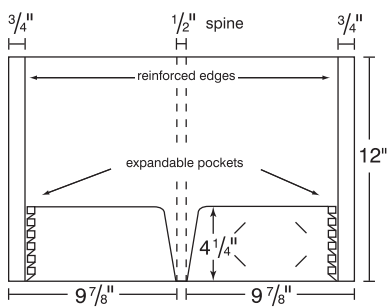

Item Number UF9-G-2
 Style G-2
 Holds 100 sheets
 (50 in each pocket)

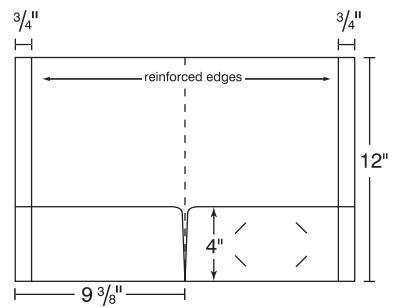

Item Number UF9-J-1 (1 pocket)
 Style J-1
Item Number UF9-J-2 (2 pockets)
 Style J-2

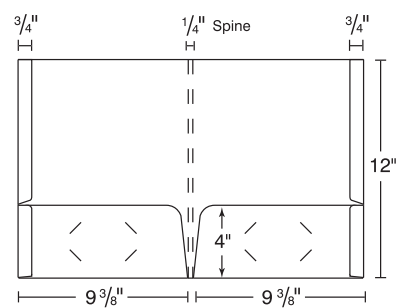

Item Number UF9-H-2
 Style H-2
 Holds 50 sheets
 (25 in each pocket)

See pages 6-11 for additional Conformer® Expansion style options

file folders

file folders

class 1 stocks	smart art code	50	100	250	500	1000	2000	2500	3000	5000
no imprint 24hr	-	\$172.55	221.30	364.40	560.30	919.60	1486.00	1765.10	1984.35	2859.25
1 standard ink 24hr	1S	\$225.35	293.40	474.05	684.15	1071.85	1687.00	1990.45	2218.85	3131.30
2 standard inks 24hr	1S	\$347.15	415.20	595.85	826.25	1247.45	1927.55	2261.45	2515.25	3511.95
1 standard foil stamp* 24hr	1S	\$306.55	377.65	565.40	784.65	1189.60	1839.25	2160.00	2405.65	3387.10
blind embossing*	1X	\$365.45	431.45	605.00	802.95	1199.75	1839.25	2160.00	2405.65	3387.10
four color process	4C	\$803.90	871.95	1052.60	1283.00	1704.20	2384.30	2718.20	2972.00	3968.70

Please note: the above prices are for class 1 stocks. For all other stocks, please add the prices below. If not specified, raised ink will be used. For more information on Smart Art Codes, visit www.smart-artwork.com.

additional stock options (add charges below to top prices)

	50	100	250	500	1000	2000	2500	3000	5000
class 2 stocks	\$29.40	37.25	53.90	72.55	108.80	182.30	218.55	254.80	399.85
class 3 stocks	\$54.90	62.75	80.40	108.80	166.60	280.30	338.10	394.95	623.30
class 4 stocks	\$76.45	88.20	118.60	166.60	259.70	446.90	541.00	634.10	1003.55
class 5 stocks	\$140.15	166.60	228.35	327.35	503.75	841.85	1008.45	1175.05	1818.90

additional options (add charges below to top prices)

	50	100	250	500	1000	2000	2500	3000	5000
heavy ink coverage	not available		\$171.90	183.80	207.45	254.85	278.50	302.20	396.95
uv coating	not available		\$171.90	183.80	207.45	254.85	278.50	302.20	396.95
each add'l standard ink color	not available		\$121.80	142.10	175.60	240.55	271.00	296.40	380.65
inside copy (above pockets)	not available		\$118.55	138.75	174.00	236.10	262.00	281.65	360.35
additional foil stamp run*	not available		\$195.20	232.45	306.85	455.60	530.55	604.50	900.80
additional blind emboss run*	not available		\$237.55	257.85	317.00	455.60	530.55	604.50	900.80

(R) Prices effective January, 2009

* price includes up to a 36 square inch die

Production time: 24 hours (ink & foil stamping),

3 working days (embossing), 5 working days (four color process)

standard stock options

class 1

low luster white 10 pt C1S
white vellum 80 lb.
ivory index 110 lb.
tag manila 125 lb.
low luster white 12 pt C1S
bright white linen 80 lb.
warm white linen 80 lb.
yellow wove 65 lb.

class 2

gloss coated white 10 pt. C1S
gray linen 80 lb.
charcoal linen 80 lb.*, ***
white felt 80 lb.
Cougar® opaque smooth white 80 lb.
lively ivory linen 80 lb.
sky blue linen 80 lb.
white laid 80 lb.
gray laid 80 lb.
ivory laid 80 lb.
warm white laid 80 lb.
burgundy linen 80 lb.***
green linen 80 lb.***
blue linen 80 lb.***
black linen 80 lb.***

class 3

tan vellum 80 lb.
ivory vellum 80 lb.
gloss coated white 12 pt. C1S
warm white linen 100 lb.
Cougar® opaque smooth white 100 lb.
hunter green felt 80 lb.***
low luster white 15 pt. C1S
bright white linen 100 lb.
white fiber 80 lb.
low luster white 10 pt. C2S**
low luster white 12 pt. C2S**
warm white smooth 80 lb.

class 4

light green felt 80 lb.
cream fiber 80 lb.
Environment® ultra bright white 80 lb.
gloss coated white 10 pt. C2S**
berry felt 80 lb.***
low luster white 14 pt. C2S**
bronzed felt 80 lb.***
Classic Crest® solar white 80 lb.
Classic Crest® natural white 80 lb.
whitestone laid 80 lb.
silverstone laid 80 lb.
burgundy linen 100 lb.***
gloss coated white 12 pt. C2S**

class 5

gloss coated black 12 pt. C1S***
gloss coated red 12 pt. C1S***
gloss coated burgundy 12 pt. C1S***
gloss coated navy 12 pt. C1S***
gloss coated silver 12 pt. C1S***
blue linen 100 lb.***
ebony felt 80 lb.***
marine felt 80 lb.***
pewter felt 80 lb.***
teal felt 80 lb.***
Classic® linen avon white 80 lb.
red felt 90 lb.***
leatherette persian blue 90 lb.***
leatherette forest green 90 lb.***

* Charcoal Linen is not available in styles A-3, F-3, FM, G, HV, L, M, N, Q, QET, QEZ, QETL, QEZL, QL, or V

** Coated two sided stock is available with four color process, flat ink, foil stamping and embossing

*** Colored High Gloss and Dark Colored stocks are available with Foil and/or Embossing only.

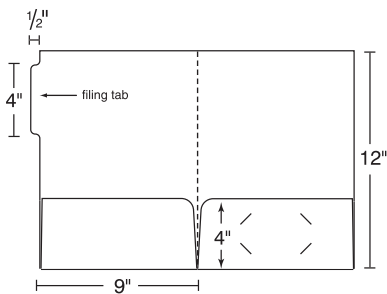

Item Number UF9-F-2T
Style F-2T

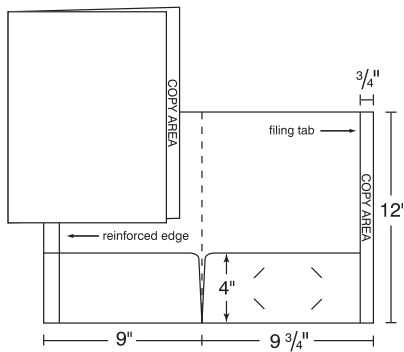

Item Number UF9-C-1 (1 pocket)
Style C-1
Item Number UF9-C-2 (2 pockets)
Style C-2

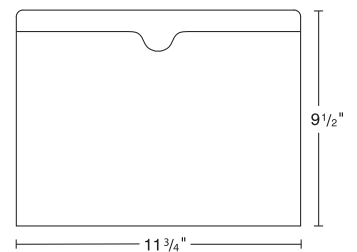

Item Number UF9-FJ
Style FJ

mini, document & literature folders

mini (1 & 2 pocket) & document folders

class 1 stocks	smart art code	50	100	250	500	1000	2000	2500	3000	5000
no imprint 24hr	-	\$165.45	210.15	322.80	492.30	781.55	1221.05	1430.15	1603.70	2288.85
1 standard ink 24hr	1S	\$218.25	282.25	432.45	616.15	933.80	1422.05	1655.50	1838.20	2560.90
2 standard inks 24hr	1S	\$340.05	404.05	554.25	758.25	1109.40	1662.60	1926.50	2134.60	2941.55
1 standard foil stamp* 24hr	1S	\$299.45	366.50	523.80	716.65	1051.55	1574.30	1825.05	2025.00	2816.70
blind embossing*	1X	\$358.35	420.30	563.40	734.95	1061.70	1574.30	1825.05	2025.00	2816.70
four color process	4C	\$796.80	860.80	1011.00	1215.00	1566.15	2119.35	2383.25	2591.35	3398.30

Please note: the above prices are for class 1 stocks. For all other stocks, please add the prices below. If not specified, raised ink will be used. For more information on Smart Art Codes, visit www.smart-artwork.com. *Price includes up to a 36 square inch die.

literature folders

class 1 stocks	smart art code	50	100	250	500	1000	2000	2500	3000	5000
no imprint 24hr	-	\$154.30	193.90	293.35	443.55	677.00	1081.00	1278.90	1471.15	2182.25
1 standard ink 24hr	1S	\$207.10	266.00	403.00	567.40	829.25	1282.00	1504.25	1706.25	2454.30
2 standard inks 24hr	1S	\$328.90	387.80	524.80	709.50	1004.85	1522.55	1775.25	2002.65	2834.95
1 standard foil stamp* 24hr	1S	\$288.30	350.25	494.35	667.90	947.00	1434.25	1673.80	1893.05	2710.10
blind embossing*	1X	\$347.20	404.05	533.95	686.20	957.15	1434.25	1673.80	1893.05	2710.10
four color process	4C	\$785.65	844.55	981.55	1166.25	1461.60	1979.30	2232.00	2459.40	3291.70

Please note: the above prices are for class 1 stocks. For all other stocks, please add the prices below. If not specified, raised ink will be used. For more information on Smart Art Codes, visit www.smart-artwork.com. *Price includes up to a 36 square inch die.

additional stock options (add charges below to top prices)

	50	100	250	500	1000	2000	2500	3000	5000
class 2 stocks	\$29.40	37.25	53.90	72.55	108.80	182.30	218.55	254.80	399.85
class 3 stocks	\$54.90	62.75	80.40	108.80	166.60	280.30	338.10	394.95	623.30
class 4 stocks	\$76.45	88.20	118.60	166.60	259.70	446.90	541.00	634.10	1003.55
class 5 stocks	\$140.15	166.60	228.35	327.35	503.75	841.85	1008.45	1175.05	1818.90

additional options (add charges below to top prices)

	50	100	250	500	1000	2000	2500	3000	5000
heavy ink coverage	not available		\$171.90	183.80	207.45	254.85	278.50	302.20	396.95
uv coating	not available		\$171.90	183.80	207.45	254.85	278.50	302.20	396.95
each add'l standard ink color	not available		\$121.80	142.10	175.60	240.55	271.00	296.40	380.65
inside copy (above pockets)	not available		\$118.55	138.75	174.00	236.10	262.00	281.65	360.35
additional foil stamp run*	not available		\$195.20	232.45	306.85	455.60	530.55	604.50	900.80
additional blind emboss run*	not available		\$237.55	257.85	317.00	455.60	530.55	604.50	900.80

(R) Prices effective January, 2009

* price includes up to a 36 square inch die

Production time: 24 hours (ink & foil stamping),

3 working days (embossing), 5 working days (four color process)

standard stock options

class 1

low luster white 10 pt C1S
white vellum 80 lb.
ivory index 110 lb.
tag manila 125 lb.
low luster white 12 pt C1S
bright white linen 80 lb.
warm white linen 80 lb.
yellow wove 65 lb.

class 2

gloss coated white 10 pt. C1S
gray linen 80 lb.
charcoal linen 80 lb.**, ***
white felt 80 lb.
Cougar® opaque smooth white 80 lb.
lively ivory linen 80 lb.
sky blue linen 80 lb.
white laid 80 lb.
gray laid 80 lb.
ivory laid 80 lb.
warm white laid 80 lb.
burgundy linen 80 lb.***
green linen 80 lb.***
blue linen 80 lb.***
black linen 80 lb.***

class 3

tan vellum 80 lb.
ivory vellum 80 lb.
gloss coated white 12 pt. C1S
warm white linen 100 lb.
Cougar® opaque smooth white 100 lb.
hunter green felt 80 lb.***
low luster white 15 pt. C1S
bright white linen 100 lb.
white fiber 80 lb.
low luster white 10 pt. C2S**
low luster white 12 pt. C2S**
warm white smooth 80 lb.

class 4

light green felt 80 lb.
cream fiber 80 lb.
Environment® ultra bright white 80 lb.
gloss coated white 10 pt. C2S**
berry felt 80 lb.***
low luster white 14 pt. C2S**
bronzed felt 80 lb.***
Classic Crest® solar white 80 lb.
Classic Crest® natural white 80 lb.
whitestone laid 80 lb.
silverstone laid 80 lb.
burgundy linen 100 lb.***
gloss coated white 12 pt. C2S**

class 5

gloss coated black 12 pt. C1S***
gloss coated red 12 pt. C1S***
gloss coated burgundy 12 pt. C1S***
gloss coated navy 12 pt. C1S***
gloss coated silver 12 pt. C1S***
blue linen 100 lb.***
ebony felt 80 lb.***
marine felt 80 lb.***
pewter felt 80 lb.***
teal felt 80 lb.***
Classic® linen avon white 80 lb.
red felt 90 lb.***
leatherette persian blue 90 lb.***
leatherette forest green 90 lb.***

* Charcoal Linen is not available in styles A-3, F-3, FM, G, HV, L, M, N, O, QET, QEZ, QETL, QEZL, QL, or V

** Coated two sided stock is available with four color process, flat ink, foil stamping and embossing

*** Colored High Gloss and Dark Colored stocks are available with Foil and/or Embossing only.

mini folders

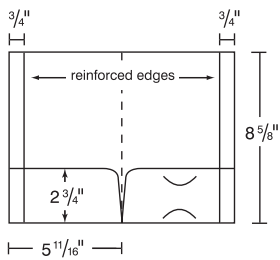

Item Number UF9-I-1 (1 pocket)
Style I-1
Item Number UF9-I-2 (2 pockets)
Style I-2

document folders

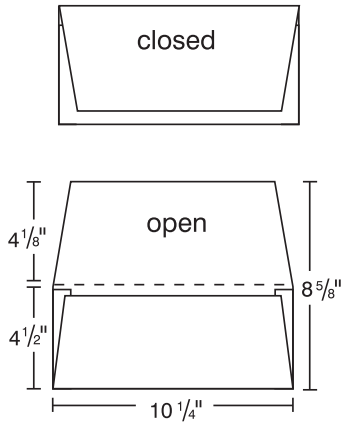

Item Number UF9-K
Style K

literature folders

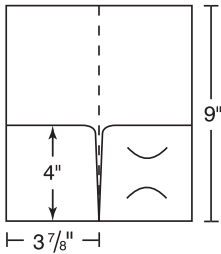

Item Number UF9-E-1 (1 pocket)
Style E-1
Item Number UF9-E-2 (2 pockets)
Style E-2

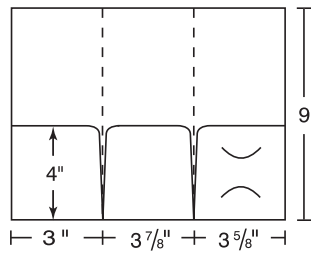

Item Number UF9-E-3 (3 pockets)
Style E-3
 See pages 6-10 for Secured Pocket Folder Pricing.

legal folders

legal folders

class 1 stocks	smart art code	50	100	250	500	1000	2000	2500	3000	5000
no imprint 24hr	-	\$240.55	312.65	463.85	694.30	1083.00	1858.50	2237.10	2532.45	3712.90
1 standard ink 24hr	1S	\$293.35	384.75	573.50	818.15	1235.25	2059.50	2462.45	2766.95	3984.95
2 standard inks 24hr	1S	\$415.15	506.55	695.30	960.25	1410.85	2300.05	2733.45	3063.35	4365.60
1 standard foil stamp* 24hr	1S	\$374.55	469.00	664.85	918.65	1353.00	2211.75	2632.00	2953.75	4240.75
blind embossing*	1X	\$433.45	522.80	704.45	936.95	1363.15	2211.75	2632.00	2953.75	4240.75
four color process	4C	not available		\$1357.05	1587.50	1976.20	2751.70	3130.30	3508.90	5022.25

Please note: the above prices are for class 1 stocks. For all other stocks, please add the prices below. If not specified, raised ink will be used. For more information on Smart Art Codes, visit www.smart-artwork.com.

additional stock options (add charges below to top prices)

	50	100	250	500	1000	2000	2500	3000	5000
class 2 stocks	\$29.40	37.25	53.90	72.55	108.80	182.30	218.55	254.80	399.85
class 3 stocks	\$54.90	62.75	80.40	108.80	166.60	280.30	338.10	394.95	623.30
class 4 stocks	\$76.45	88.20	118.60	166.60	259.70	446.90	541.00	634.10	1003.55
class 5 stocks	\$140.15	166.60	228.35	327.35	503.75	841.85	1008.45	1175.05	1818.90

additional options (add charges below to top prices)

	50	100	250	500	1000	2000	2500	3000	5000
Conformer® Expansion Pocket (2 pockets)	\$30.65	37.75	56.55	78.45	118.95	183.95	216.00	240.55	338.70
heavy ink coverage	not available		\$171.90	183.80	207.45	254.85	278.50	302.20	396.95
uv coating	not available		\$171.90	183.80	207.45	254.85	278.50	302.20	396.95
each add'l standard ink color	not available		\$121.80	142.10	175.60	240.55	271.00	296.40	380.65
inside copy (above pockets)	not available		\$118.55	138.75	174.00	236.10	262.00	281.65	360.35
additional foil stamp run*	not available		\$195.20	232.45	306.85	455.60	530.55	604.50	900.80
additional blind emboss run*	not available		\$237.55	257.85	317.00	455.60	530.55	604.50	900.80

(R) Prices effective January, 2009

* price includes up to a 36 square inch die

Production time: 24 hours (ink & foil stamping),

3 working days (embossing), 5 working days (four color process)

standard stock options

class 1

low luster white 10 pt C1S
white vellum 80 lb.
ivory index 110 lb.
tag manila 125 lb.
low luster white 12 pt C1S
bright white linen 80 lb.
warm white linen 80 lb.
yellow wove 65 lb.

class 2

gloss coated white 10 pt. C1S
gray linen 80 lb.
charcoal linen 80 lb.*, ***
white felt 80 lb.
Cougar® opaque smooth white 80 lb.
lively ivory linen 80 lb.
sky blue linen 80 lb.
white laid 80 lb.
gray laid 80 lb.
ivory laid 80 lb.
warm white laid 80 lb.
burgundy linen 80 lb.***
green linen 80 lb.***
blue linen 80 lb.***
black linen 80 lb.***

class 3

tan vellum 80 lb.
ivory vellum 80 lb.
gloss coated white 12 pt. C1S
warm white linen 100 lb.
Cougar® opaque smooth white 100 lb.
hunter green felt 80 lb.***
low luster white 15 pt. C1S
bright white linen 100 lb.
white fiber 80 lb.
low luster white 10 pt. C2S**
low luster white 12 pt. C2S**
warm white smooth 80 lb.

class 4

light green felt 80 lb.
cream fiber 80 lb.
Environment® ultra bright white 80 lb.
gloss coated white 10 pt. C2S**
berry felt 80 lb.***
low luster white 14 pt. C2S**
bronzed felt 80 lb.***
Classic Crest® solar white 80 lb.
Classic Crest® natural white 80 lb.
whitestone laid 80 lb.
silverstone laid 80 lb.
burgundy linen 100 lb.***
gloss coated white 12 pt. C2S**

class 5

gloss coated black 12 pt. C1S***
gloss coated red 12 pt. C1S***
gloss coated burgundy 12 pt. C1S***
gloss coated navy 12 pt. C1S***
gloss coated silver 12 pt. C1S***
blue linen 100 lb.***
ebony felt 80 lb.***
marine felt 80 lb.***
pewter felt 80 lb.***
teal felt 80 lb.***
Classic® linen avon white 80 lb.
red felt 90 lb.***
leatherette persian blue 90 lb.***
leatherette forest green 90 lb.***

* Charcoal Linen is not available in styles A-3, F-3, FM, G, HV, L, M, N, Q, QET, QEZ, QETL, QEZL, QL, or V

** Coated two sided stock is available with four color process, flat ink, foil stamping and embossing

*** Colored High Gloss and Dark Colored stocks are available with Foil and/or Embossing only.

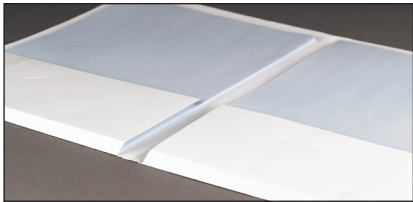

Thicker materials like booklets and catalogs fit perfectly in our roomier Conformer® Expansion Folder Style QL-2. See Additional Options for Expansion Pocket pricing.

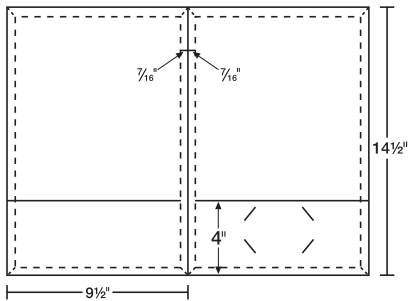

Conformer® Expansion Folder
Item Number UF9-QL-2
 Style QL-2

U.S. patent number is required to print on all Conformer® Expansion Products:
 6,116,651 Conformer® Expansion Folder • 6,227,444 Conformer® Expansion Envelope. Conformer® is a registered trademark of CONFORMER EXPANSION PRODUCTS, INC.

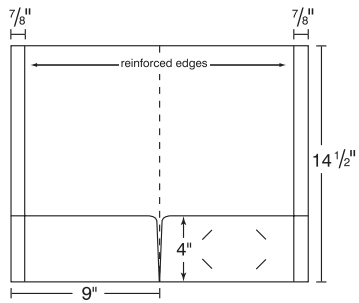

Item Number UF9-L-1 (1 pocket)
 Style L-1
Item Number UF9-L-2 (2 pockets)
 Style L-2

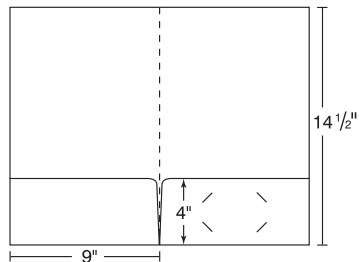

Item Number UF9-M-1 (1 pocket)
 Style M-1
Item Number UF9-M-2 (2 pockets)
 Style M-2

tri-fold & vertical folders

class 1 stocks	smart art code	250	500	1000	2000	2500	3000	5000
no imprint 24hr	-	\$853.65	1306.30	2022.90	3378.95	3958.50	4445.70	6308.25
1 standard ink 24hr	1S	\$963.30	1430.15	2175.15	3579.95	4183.85	4680.20	6580.30
2 standard inks 24hr	1S	\$1085.10	1572.25	2350.75	3820.50	4454.85	4976.60	6960.95
1 standard foil stamp* 24hr	1S	\$1054.65	1530.65	2292.90	3732.20	4353.40	4867.00	6836.10
blind embossing*	1X	\$1094.25	1548.95	2303.05	3732.20	4353.40	4867.00	6836.10
four color process	4C	\$2448.25	3079.50	3931.10	5307.45	5897.15	6394.50	8328.10

Please note: the above prices are for class 1 stocks. For all other stocks, please add the prices below. If not specified, raised ink will be used. For more information on Smart Art Codes, visit www.smart-artwork.com. *Price includes up to a 36 square inch die.

additional stock options (add charges below to top prices)

	250	500	1000	2000	2500	3000	5000
class 2 stocks	\$53.90	72.55	108.80	182.30	218.55	254.80	399.85
class 3 stocks	\$80.40	108.80	166.60	280.30	338.10	394.95	623.30
class 4 stocks	\$118.60	166.60	259.70	446.90	541.00	634.10	1003.55
class 5 stocks	\$228.35	327.35	503.75	841.85	1008.45	1175.05	1818.90

additional options (add charges below to top prices)

	250	500	1000	2000	2500	3000	5000
heavy ink coverage	\$171.90	183.80	207.45	254.85	278.50	302.20	396.95
uv coating	\$171.90	183.80	207.45	254.85	278.50	302.20	396.95
each add'l standard ink color	\$121.80	142.10	175.60	240.55	271.00	296.40	380.65
inside copy (above pockets)	\$118.55	138.75	174.00	236.10	262.00	281.65	360.35
additional foil stamp run*	\$195.20	232.45	306.85	455.60	530.55	604.50	900.80
additional blind emboss run*	\$237.55	257.85	317.00	455.60	530.55	604.50	900.80

(F) Prices effective January, 2009
* price includes up to a 36 square inch die

Production time: 24 hours (ink & foil stamping),
3 working days (embossing), 5 working days (four color process)

standard stock options

class 1

low luster white 10 pt C1S
white vellum 80 lb.
ivory index 110 lb.
tag manila 125 lb.
low luster white 12 pt C1S
bright white linen 80 lb.
warm white linen 80 lb.
yellow wove 65 lb.

class 2

gloss coated white 10 pt. C1S
gray linen 80 lb.
charcoal linen 80 lb.*, ***
white felt 80 lb.
Cougar® opaque smooth white 80 lb.
lively ivory linen 80 lb.
sky blue linen 80 lb.
white laid 80 lb.
gray laid 80 lb.
ivory laid 80 lb.
warm white laid 80 lb.
burgundy linen 80 lb.***
green linen 80 lb.***
blue linen 80 lb.***
black linen 80 lb.***

class 3

tan vellum 80 lb.
ivory vellum 80 lb.
gloss coated white 12 pt. C1S
warm white linen 100 lb.
Cougar® opaque smooth white 100 lb.
hunter green felt 80 lb.***
low luster white 15 pt. C1S
bright white linen 100 lb.
white fiber 80 lb.
low luster white 10 pt. C2S**
low luster white 12 pt. C2S**
warm white smooth 80 lb.

class 4

light green felt 80 lb.
cream fiber 80 lb.
Environment® ultra bright white 80 lb.
gloss coated white 10 pt. C2S**
berry felt 80 lb.***
low luster white 14 pt. C2S**
bronzed felt 80 lb.***
Classic Crest® solar white 80 lb.
Classic Crest® natural white 80 lb.
whitestone laid 80 lb.
silverstone laid 80 lb.
burgundy linen 100 lb.***
gloss coated white 12 pt. C2S**

class 5

gloss coated black 12 pt. C1S***
gloss coated red 12 pt. C1S***
gloss coated burgundy 12 pt. C1S***
gloss coated navy 12 pt. C1S***
gloss coated silver 12 pt. C1S***
blue linen 100 lb.***
ebony felt 80 lb.***
marine felt 80 lb.***
pewter felt 80 lb.***
teal felt 80 lb.***
Classic® linen avon white 80 lb.
red felt 90 lb.***
leatherette persian blue 90 lb.***
leatherette forest green 90 lb.***

* Charcoal Linen is not available in styles A-3, F-3, FM, G, HV, L, M, N, Q, QET, QEZ, QETL, QEZL, QL, or V
** Coated two sided stock is available with four color process, flat ink, foil stamping and embossing
*** Colored High Gloss and Dark Colored stocks are available with Foil and/or Embossing only.

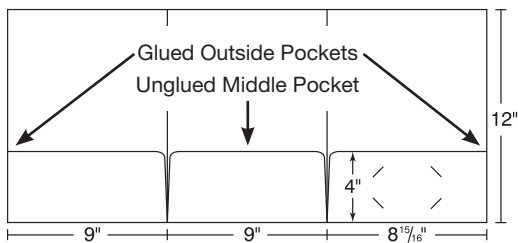

Item Number UF9-F-3
(glued outside pockets, unglued middle pocket)
Style F-3

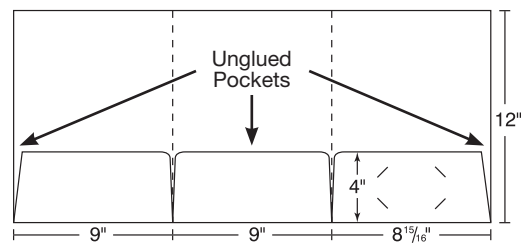

Item Number UF9-A-3
(all pockets unglued)
Style A-3

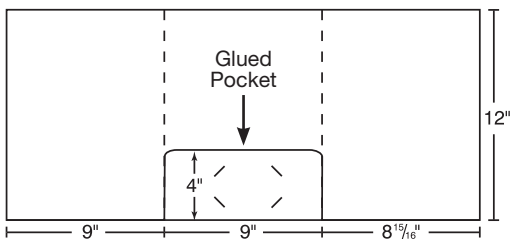

Item Number UF9-FM-1
(glued middle pocket)
Style FM-1

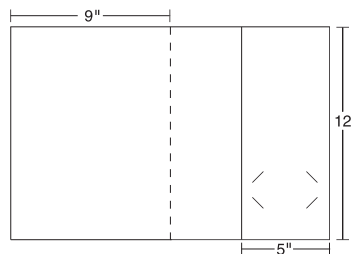

Item Number UF9-V-1
Style V-1

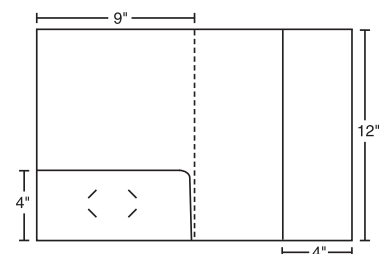

Item Number UF9-HV-2
Style HV-2

loose pocket folders

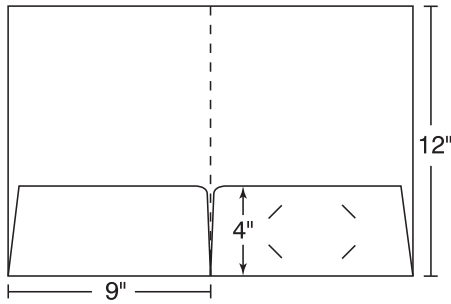

Item Number UF9-A-1 (1 unglued pocket)

Style A-1

Item Number UF9-A-2 (2 unglued pockets)

Style A-2

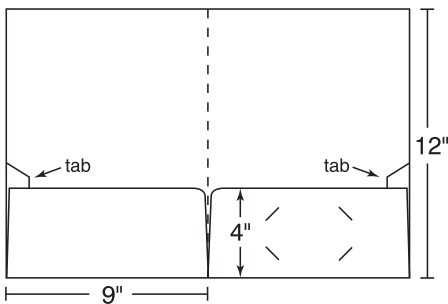

Item Number UF9-A-1S (1 unglued pocket, self-assemble tab)

Style A-1

Item Number UF9-A-2S (1 unglued pocket, self-assemble tabs)

Style A-2



loose pocket folders

class 1 stocks	smart art code	50	100	250	500	1000	2000	2500	3000	5000
no imprint 24hr	-	\$155.30	205.05	341.05	497.35	789.70	1325.60	1573.25	1778.30	2591.30
1 standard ink 24hr	1S	\$208.10	277.15	450.70	621.20	941.95	1526.60	1798.60	2012.80	2863.35
2 standard inks 24hr	1S	\$329.90	398.95	572.50	763.30	1117.55	1767.15	2069.60	2309.20	3244.00
1 standard foil stamp* 24hr	1S	\$289.30	361.40	542.05	721.70	1059.70	1678.85	1968.15	2199.60	3119.15
blind embossing*	1X	\$348.20	415.20	581.65	740.00	1069.85	1678.85	1968.15	2199.60	3119.15
four color process	4C	\$786.65	855.70	1029.25	1220.05	1574.30	2223.90	2526.35	2765.95	3700.75

Please note: the above prices are for class 1 stocks. For all other stocks, please add the prices below. If not specified, raised ink will be used. For more information on Smart Art Codes, visit www.smart-artwork.com.

additional stock options (add charges below to top prices)

	50	100	250	500	1000	2000	2500	3000	5000
class 2 stocks	\$29.40	37.25	53.90	72.55	108.80	182.30	218.55	254.80	399.85
class 3 stocks	\$54.90	62.75	80.40	108.80	166.60	280.30	338.10	394.95	623.30
class 4 stocks	\$76.45	88.20	118.60	166.60	259.70	446.90	541.00	634.10	1003.55
class 5 stocks	\$140.15	166.60	228.35	327.35	503.75	841.85	1008.45	1175.05	1818.90

See page 22 for standard stock options.

additional options (add charges below to top prices)

	50	100	250	500	1000	2000	2500	3000	5000
heavy ink coverage	not available		\$171.90	183.80	207.45	254.85	278.50	302.20	396.95
uv coating	not available		\$171.90	183.80	207.45	254.85	278.50	302.20	396.95
each add'l standard ink color	not available		\$121.80	142.10	175.60	240.55	271.00	296.40	380.65
inside copy (above pockets)	not available		\$118.55	138.75	174.00	236.10	262.00	281.65	360.35
additional foil stamp run*	not available		\$195.20	232.45	306.85	455.60	530.55	604.50	900.80
additional blind emboss run*	not available		\$237.55	257.85	317.00	455.60	530.55	604.50	900.80

(R) Prices effective January, 2009

* price includes up to a 36 square inch die

Production time: 24 hours (ink & foil stamping),
3 working days (embossing), 5 working days (four color process)

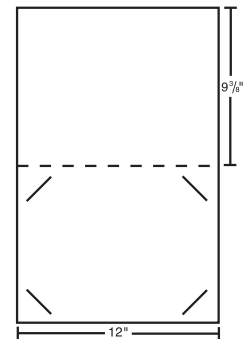

Item Number UF9-CH
Style CH

certificate holders

class 1 stocks	smart art code	50	100	250	500	1000	2000	2500	3000	5000
no imprint 24hr	-	\$55.85	87.30	180.70	324.80	595.80	1003.85	1176.40	1347.95	2033.05
1 standard ink 24hr	1S	\$108.65	159.40	290.35	448.65	748.05	1204.85	1401.75	1582.45	2305.10
2 standard inks 24hr	1S	\$230.45	281.20	412.15	590.75	923.65	1445.40	1672.75	1878.85	2685.75
1 standard foil stamp* 24hr	1S	\$189.85	243.65	381.70	549.15	865.80	1357.10	1571.30	1769.25	2560.90
blind embossing*	1X	\$248.75	297.45	421.30	567.45	875.95	1357.10	1571.30	1769.25	2560.90
four color process	4C	\$687.20	737.95	868.90	1047.50	1380.40	1902.15	2129.50	2335.60	3142.50

Please note: the above prices are for class 1 stocks. For all other stocks, please add the prices below. If not specified, raised ink will be used. For more information on Smart Art Codes, visit www.smart-artwork.com.

additional stock options (add charges below to top prices)

	50	100	250	500	1000	2000	2500	3000	5000
class 2 stocks	\$29.40	37.25	53.90	72.55	108.80	182.30	218.55	254.80	399.85
class 3 stocks	\$54.90	62.75	80.40	108.80	166.60	280.30	338.10	394.95	623.30
class 4 stocks	\$76.45	88.20	118.60	166.60	259.70	446.90	541.00	634.10	1003.55
class 5 stocks	\$140.15	166.60	228.35	327.35	503.75	841.85	1008.45	1175.05	1818.90

See page 22 for standard stock options.

additional options (add charges below to top prices)

	50	100	250	500	1000	2000	2500	3000	5000
heavy ink coverage	not available		\$171.90	183.80	207.45	254.85	278.50	302.20	396.95
uv coating	not available		\$171.90	183.80	207.45	254.85	278.50	302.20	396.95
each add'l standard ink color	not available		\$121.80	142.10	175.60	240.55	271.00	296.40	380.65
inside copy (above pockets)	not available		\$118.55	138.75	174.00	236.10	262.00	281.65	360.35
additional foil stamp run*	not available		\$195.20	232.45	306.85	455.60	530.55	604.50	900.80
additional blind emboss run*	not available		\$237.55	257.85	317.00	455.60	530.55	604.50	900.80

(R) Prices effective January, 2009
* price includes up to a 36 square inch die

Production time: 24 hours (ink & foil stamping),
3 working days (embossing), 5 working days (four color process)

report covers

one or two piece

class 1 stocks	smart art code	50	100	250	500	1000	2000	2500	3000	5000
no imprint 24hr	-	\$55.85	87.30	180.70	324.80	595.80	1003.85	1176.40	1347.95	2033.05
1 standard ink 24hr	1S	\$108.65	159.40	290.35	448.65	748.05	1204.85	1401.75	1582.45	2305.10
2 standard inks 24hr	1S	\$230.45	281.20	412.15	590.75	923.65	1445.40	1672.75	1878.85	2685.75
1 standard foil stamp* 24hr	1S	\$189.85	243.65	381.70	549.15	865.80	1357.10	1571.30	1769.25	2560.90
blind embossing*	1X	\$248.75	297.45	421.30	567.45	875.95	1357.10	1571.30	1769.25	2560.90
four color process	4C	\$687.20	737.95	868.90	1047.50	1380.40	1902.15	2129.50	2335.60	3142.50

Please note: the above prices are for class 1 stocks. For all other stocks, please add the prices below. If not specified, raised ink will be used. For more information on Smart Art Codes, visit www.smart-artwork.com. *Price includes up to a 36 square inch die.

legal one or two piece

class 1 stocks	smart art code	50	100	250	500	1000	2000	2500	3000	5000
no imprint 24hr	-	\$89.35	120.80	214.20	362.35	633.40	994.70	1174.35	1353.00	2065.55
1 standard ink 24hr	1S	\$142.15	192.90	323.85	486.20	785.65	1195.70	1399.70	1587.50	2337.60
2 standard inks 24hr	1S	\$263.95	314.70	445.65	628.30	961.25	1436.25	1670.70	1883.90	2718.25
1 standard foil stamp* 24hr	1S	\$223.35	277.15	415.20	586.70	903.40	1347.95	1569.25	1774.30	2593.40
blind embossing*	1X	\$282.25	330.95	454.80	605.00	913.55	1347.95	1569.25	1774.30	2593.40
four color process	4C	not available	\$902.40	1085.05	1418.00	1893.00	2127.45	2340.65	3175.00	

Please note: the above prices are for class 1 stocks. For all other stocks, please add the prices below. If not specified, raised ink will be used. For more information on Smart Art Codes, visit www.smart-artwork.com. *Price includes up to a 36 square inch die.

additional stock options (add charges below to top prices)

	50	100	250	500	1000	2000	2500	3000	5000
class 2 stocks	\$29.40	37.25	53.90	72.55	108.80	182.30	218.55	254.80	399.85
class 3 stocks	\$54.90	62.75	80.40	108.80	166.60	280.30	338.10	394.95	623.30
class 4 stocks	\$76.45	88.20	118.60	166.60	259.70	446.90	541.00	634.10	1003.55
class 5 stocks	\$140.15	166.60	228.35	327.35	503.75	841.85	1008.45	1175.05	1818.90

See page 22 for standard stock options.

additional options (add charges below to top prices)

	50	100	250	500	1000	2000	2500	3000	5000
heavy ink coverage	not available		\$171.90	183.80	207.45	254.85	278.50	302.20	396.95
uv coating	not available		\$171.90	183.80	207.45	254.85	278.50	302.20	396.95
each add'l standard ink color	not available		\$121.80	142.10	175.60	240.55	271.00	296.40	380.65
inside copy (above pockets)	not available		\$118.55	138.75	174.00	236.10	262.00	281.65	360.35
additional foil stamp run*	not available		\$195.20	232.45	306.85	455.60	530.55	604.50	900.80
additional blind emboss run*	not available		\$237.55	257.85	317.00	455.60	530.55	604.50	900.80

(R) Prices effective January, 2009

* price includes up to a 36 square inch die

Production time: 24 hours (ink & foil stamping),

3 working days (embossing), 5 working days (four color process)

standard stock options

class 1

low luster white 10 pt C1S
white vellum 80 lb.
ivory index 110 lb.
tag manila 125 lb.
low luster white 12 pt C1S
bright white linen 80 lb.
warm white linen 80 lb.
yellow wove 65 lb.

class 2

gloss coated white 10 pt. C1S
gray linen 80 lb.
charcoal linen 80 lb.**, ***
white felt 80 lb.
Cougar® opaque smooth white 80 lb.
lively ivory linen 80 lb.
sky blue linen 80 lb.
white laid 80 lb.
gray laid 80 lb.
ivory laid 80 lb.
warm white laid 80 lb.
burgundy linen 80 lb.***
green linen 80 lb.***
blue linen 80 lb.***
black linen 80 lb.***

class 3

tan vellum 80 lb.
ivory vellum 80 lb.
gloss coated white 12 pt. C1S
warm white linen 100 lb.
Cougar® opaque smooth white 100 lb.
hunter green felt 80 lb.***
low luster white 15 pt. C1S
bright white linen 100 lb.
white fiber 80 lb.
low luster white 10 pt. C2S**
low luster white 12 pt. C2S**
warm white smooth 80 lb.

class 4

light green felt 80 lb.
cream fiber 80 lb.
Environment® ultra bright white 80 lb.
gloss coated white 10 pt. C2S**
berry felt 80 lb.***
low luster white 14 pt. C2S**
bronzed felt 80 lb.***
Classic Crest® solar white 80 lb.
Classic Crest® natural white 80 lb.
whitestone laid 80 lb.
silverstone laid 80 lb.
burgundy linen 100 lb.***
gloss coated white 12 pt. C2S**

class 5

gloss coated black 12 pt. C1S***
gloss coated red 12 pt. C1S***
gloss coated burgundy 12 pt. C1S***
gloss coated navy 12 pt. C1S***
gloss coated silver 12 pt. C1S***
blue linen 100 lb.***
ebony felt 80 lb.***
marine felt 80 lb.***
pewter felt 80 lb.***
teal felt 80 lb.***
Classic® linen avon white 80 lb.
red felt 90 lb.***
leatherette persian blue 90 lb.***
leatherette forest green 90 lb.***

* Charcoal Linen is not available in styles A-3, F-3, FM, G, HV, L, M, N, Q, QET, QEZ, QETL, QEZL, QL, or V

** Coated two sided stock is available with four color process, flat ink, foil stamping and embossing

*** Colored High Gloss and Dark Colored stocks are available with Foil and/or Embossing only.

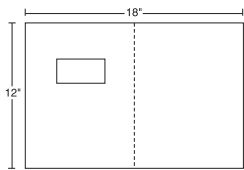
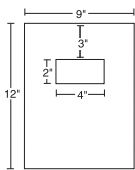

one piece
Item Number UF9-R-1
 (one piece report cover)
 Style R-1
Item Number UF9-W-1
 (one piece report cover w/ window)
 Style W-1

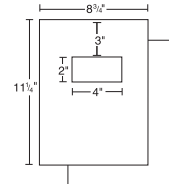

two piece
Item Number UF9-R-2
 (two piece report cover)
 Style R-2
Item Number UF9-W-2
 (two piece report cover w/ window)
 Style W-2

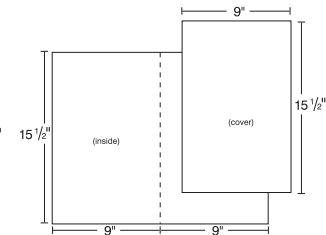
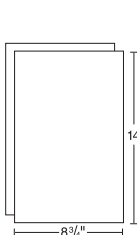

legal size
Item Number UF9-R-1L
 (one piece legal report cover)
 Style R-1L
Item Number UF9-R-2L
 (two piece legal report cover)
 Style R-2L

Item Number UF9-W-1L
 (one piece legal report cover w/ window)
 Style W-1L
Item Number UF9-W-2L
 (two piece legal report cover w/ window)
 Style W-2L

multicolor folders

Multicolor Features

- 9" x 12" Secured Pocket Folder
- available in flat ink
- price includes:
 - one photo or logo scan
 - up to 20 lines of type
- stock: Smooth White Cover 80 lb.
- heavy ink coverage not available.

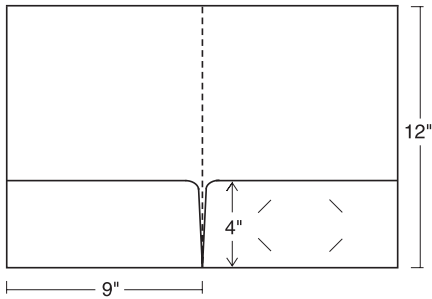

Item Number UF9-MC-2
Style MC-2



Multicolor Inks

N0001	N0002	N0003	N0004	N0005	N0006	N0007	N0008	N0009	N0010	N0011	N0012	N0013
N0014	N0015	N0016	N0017	N0018	N0019	N0020	N0021	N0022	N0023	N0024	N0025	N0026
N0027	N0028	N0029	N0030	N0031	N0032	N0033	N0034	N0035	N0036	N0037	N0038	N0039
N0040	N0041	N0042	N0043	N0044	N0045	N0046	N0047	N0048	N0050	N0051	N0053	N0054
N0055	N0056	N0057	N0058	N0059	N0060	N0061	N0062	N0063	N0098	N0099	Note: All ink colors will be printed with flat ink.	

	smart art code	50	100	150	200	250	500	1000	2000	2500
1 color	4C	\$254.75	348.95	422.45	490.75	553.90	829.35	1320.05	2904.75	3697.10
2 color	4C	\$269.20	367.55	450.40	529.10	602.55	929.75	1509.55	3192.25	4033.60
3 color	4C	\$283.70	386.25	478.35	567.40	651.25	1030.15	1699.00	3479.70	4370.05
4 color	4C	\$298.25	404.85	506.30	605.65	699.90	1130.60	1888.45	3767.15	4706.50
5 color	4C	\$312.70	423.50	534.25	644.00	748.60	1231.00	2077.90	4054.60	5043.00
6 color	4C	\$327.20	442.10	562.25	682.30	797.20	1331.45	2267.35	4342.10	5379.45
7 color	4C	\$341.65	460.75	590.15	720.60	845.85	1431.90	2456.85	4629.35	5715.95

(R) Prices effective January, 2009

For more information on Smart Art Codes, visit www.smart-artwork.com.

Production time: 5 working days

photo holders

	smart art code	100	200	250	500	1000
PHA	1S	\$181.20	250.20	284.75	440.00	750.60
PHB	1S	\$186.35	260.55	297.65	465.90	802.40

(R) Prices effective January, 2009

Production time: 8 working days

For more information on Smart Art Codes, visit www.smart-artwork.com.

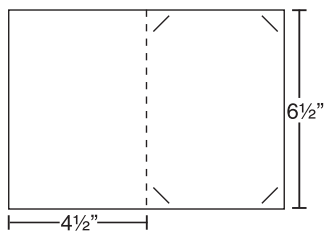

Item Number UF9-PHA
Style PHA
Fits 4" x 6" photo

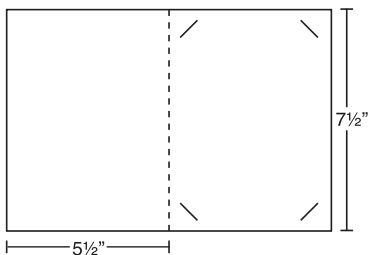

Item Number UF9-PHB
Style PHB
Fits 5" x 7" photo

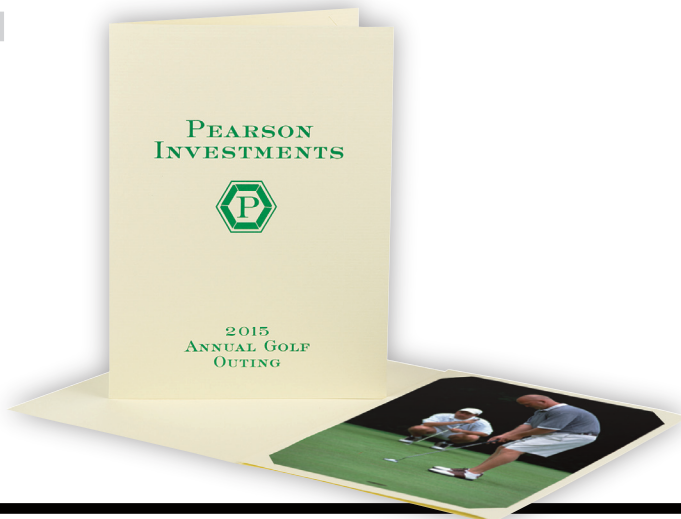

NEW!

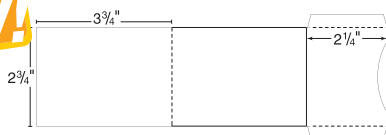

Item Number UF9-CF
Style CF

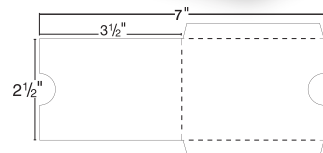

Item Number UF9-CJ
Style CJ

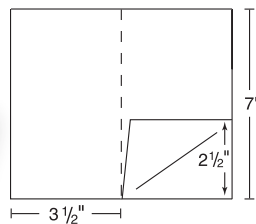

Item Number UF9-Y
Style Y

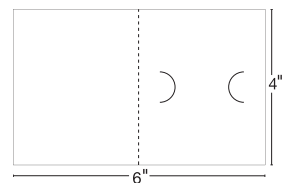

Item Number UF9-CU
Style CU

card carriers

class 1 stocks	smart art code	250	500	1000	2000	2500	3000	5000
no imprint	-	\$256.00	313.00	354.79	537.31	681.00	829.33	1195.00
1 standard ink	1S	\$308.00	384.00	432.42	680.56	803.00	953.05	1345.00
2 standard inks	1S	\$428.00	504.00	520.17	803.75	943.00	1087.17	1518.00
1 standard foil stamp*	1S	\$388.00	467.00	496.78	768.06	902.00	1037.63	1461.00
blind embossing*	1X	\$446.00	520.00	511.02	783.38	920.00	1044.73	1471.00
four color process	4C	\$878.00	954.00	873.36	1221.87	1393.00	1473.74	1968.00

Please note: the above prices are for class 1 stocks. For all other stocks, please add the prices below. If not specified, raised ink will be used. For more information on Smart Art Codes, visit www.smart-artwork.com. *Price includes up to a 36 square inch die.

additional stock options (add charges below to top prices)

	250	500	1000	2000	2500	3000	5000
class 2 stocks	\$53.90	72.55	108.80	182.30	218.55	254.80	399.85
class 3 stocks	\$80.40	108.80	166.60	280.30	338.10	394.95	623.30
class 4 stocks	\$118.60	166.60	259.70	446.90	541.00	634.10	1003.55
class 5 stocks	\$228.35	327.35	503.75	841.85	1008.45	1175.05	1818.90

See page 26 for stock options.

additional options (add charges below to top prices)

	250	500	1000	2000	2500	3000	5000
heavy ink coverage	\$171.90	183.80	207.45	254.85	278.50	302.20	396.95
uv coating	\$171.90	183.80	207.45	254.85	278.50	302.20	396.95
each add'l standard ink color	\$121.80	142.10	175.60	240.55	271.00	296.40	380.65
inside copy (above pockets)	\$118.55	138.75	174.00	236.10	262.00	281.65	360.35
additional foil stamp run*	\$195.20	232.45	306.85	455.60	530.55	604.50	900.80
additional blind emboss run*	\$237.55	257.85	317.00	455.60	530.55	604.50	900.80

(R) Prices effective January, 2009

Production time: 5 working days

* price includes up to a 36 square inch die

stepped inserts

stepped inserts

style FL1	smart art code	# of sheets	100	250	500	1000	1500	2000	5000
1 standard ink	1S	5	\$430.40	567.40	703.40	960.20	1193.65	1435.25	2841.00
2 standard inks	1S	5	\$588.70	709.50	848.55	1116.50	1372.30	1631.10	3157.70
four color process	4C	5	\$1161.20	1197.70	1357.05	1657.50	1927.50	2217.80	3888.50
1 standard ink	1S	6	\$445.60	586.70	737.90	1022.10	1279.95	1547.90	3124.20
2 standard inks	1S	6	\$609.00	733.85	889.15	1188.60	1471.75	1760.05	3471.30
four color process	4C	6	\$1190.60	1228.15	1404.80	1735.65	2036.10	2356.85	4212.25
1 standard ink	1S	7	\$465.90	613.10	790.70	1127.70	1459.60	1767.15	3682.45
2 standard inks	1S	7	\$635.40	766.35	953.10	1312.40	1678.85	2008.70	4092.50
four color process	4C	7	\$1234.25	1296.15	1438.25	1832.10	2192.40	2576.10	4833.45
1 standard ink	1S	8	\$480.10	631.35	823.20	1188.60	1527.60	1877.75	3960.55
2 standard inks	1S	8	\$654.70	789.70	992.70	1382.45	1757.00	2134.55	4401.05
four color process	4C	8	\$1384.50	1428.10	1652.45	2066.55	2464.45	2868.40	5256.70

style FL2	smart art code	# of sheets	100	250	500	1000	1500	2000	5000
1 standard ink	1S	5	\$297.40	391.80	490.25	672.95	840.45	1010.95	2021.90
2 standard inks	1S	5	\$406.00	510.55	591.75	783.60	966.30	1149.00	2247.25
four color process	4C	5	\$838.40	864.80	978.50	1191.65	1382.45	1587.50	2769.95
1 standard ink	1S	6	\$331.90	442.55	515.65	717.60	903.35	1094.20	2214.75
2 standard inks	1S	6	\$442.55	553.20	622.20	835.35	1039.40	1243.40	2461.40
four color process	4C	6	\$862.75	890.15	1016.05	1249.50	1461.60	1686.95	2993.25
1 standard ink	1S	7	\$334.95	441.55	560.30	797.80	1016.05	1242.40	2582.20
2 standard inks	1S	7	\$457.80	552.20	676.00	927.75	1168.30	1411.90	2869.40
four color process	4C	7	\$1018.05	1050.55	1196.70	1468.70	1719.45	1985.35	3540.35
1 standard ink	1S	8	\$347.15	456.75	584.65	841.45	1076.95	1320.55	2765.90
2 standard inks	1S	8	\$474.00	571.45	705.45	979.50	1238.30	1501.20	3073.45
four color process	4C	8	\$1044.45	1076.95	1234.25	1529.60	1800.65	2084.85	3744.35

style FL3	smart art code	# of sheets	100	250	500	1000	1500	2000	5000
1 standard ink	1S	5	\$297.40	391.80	490.25	641.50	775.50	913.50	1722.45
2 standard inks	1S	5	\$406.00	490.25	590.75	746.05	892.20	1038.35	1914.30
four color process	4C	5	\$787.65	813.05	904.40	1068.80	1226.15	1386.50	2327.40
1 standard ink	1S	6	\$308.60	407.05	514.60	685.15	839.40	993.70	1915.30
2 standard inks	1S	6	\$422.25	509.55	621.20	796.80	965.30	1129.70	2128.45
four color process	4C	6	\$803.90	829.25	931.80	1115.50	1293.15	1471.75	2536.50
1 standard ink	1S	7	\$329.90	434.45	554.20	765.35	957.15	1154.05	2327.40
2 standard inks	1S	7	\$450.70	544.05	668.90	890.15	1100.30	1312.40	2586.25
four color process	4C	7	\$824.20	850.60	980.50	1221.05	1439.30	1670.70	3043.00
1 standard ink	1S	8	\$341.05	449.65	579.60	810.00	1020.10	1236.30	2519.25
2 standard inks	1S	8	\$465.90	562.35	699.35	941.95	1173.35	1405.80	2799.40
four color process	4C	8	\$1015.00	1046.50	1188.60	1443.35	1685.95	1933.60	3391.15

(R) Prices effective January, 2009

Production time: add 6 working days to folder production

Price includes one-sided printing. For second side printing, please call for quote. For more information on Smart Art Codes, visit www.smart-artwork.com.

Stepped Insert Features

- **horizontal stepped inserts shown.** Vertical stepped inserts available. Please contact us for a quote.
- **stock:** gloss coated or matte text white 80 lb.
- **size:** 8½" x 11", 5" x 8½", 3½" x 8½", insert sheets have a ½" difference in height. Additional sheet sizes available, please contact us for a quote.
- **collate:** price includes collating and insertion
- all inserts will be placed in the right pocket unless otherwise specified.

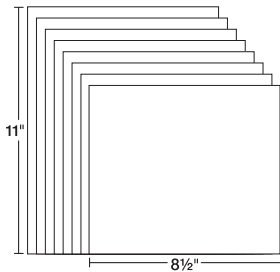
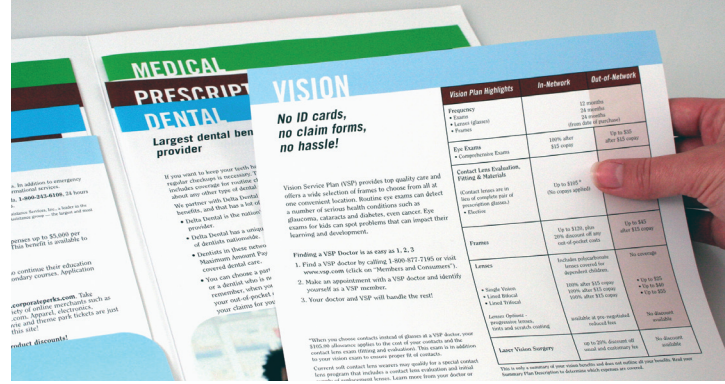

Item Number UF9-ISP-FL1
Fits 9" x 12" Folder
Style FL1

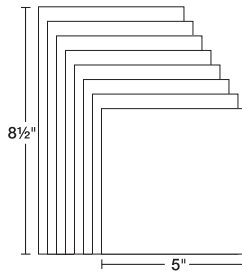

Item Number UF9-ISP-FL2
Fits Mini Folder
Style FL2

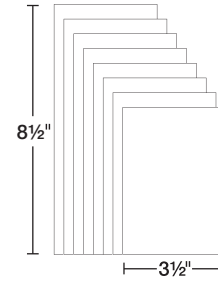

Item Number UF9-ISP-FL3
Fits Literature Folder
Style FL3

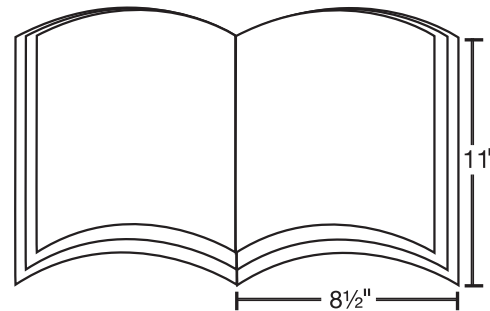

Item Number UF9-ISC
Style ISC

Stitched Insert Features

- **stock:** gloss coated white 80 lb. text
- **imprint:** four color, both sides
- **size:** 11" x 17" open; 8½" x 11" closed. Additional sheet sizes available, please call for quote.

	# of sheets	# of pages	1000	2000	2500	3000	4000	5000
ISC	1	4	\$1370.25	1860.85	1943.75	2182.25	2706.70	3007.85
ISC	2	8	\$1908.25	2368.35	2787.95	3197.25	4060.00	4406.85
ISC	3	12	\$2625.50	3383.35	3926.45	4567.50	5413.35	6017.25
ISC	4	16	\$3325.85	4736.70	5066.60	5582.50	6766.70	7714.00

(R) Prices effective January, 2009

Production time: add 5 working days to folder production

Price includes two-sided printing and stitching. For more information on Smart Art Codes, visit www.smart-artwork.com.

Conformer® Expansion Envelopes

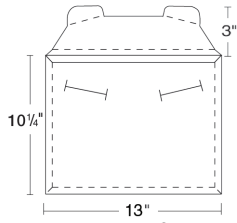

Conformer® Envelope
Item Number UF9-QET
Style QET

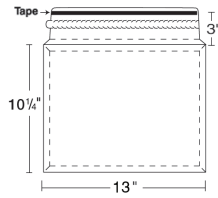

Conformer® Envelope
Item Number UF9-QEZ
Style QEZ

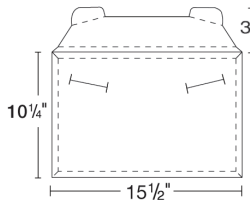

Legal Conformer® Envelope
Item Number UF9-QETL
Style QETL

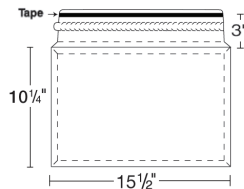

Legal Conformer® Envelope
Item Number UF9-QEZL
Style QEZL

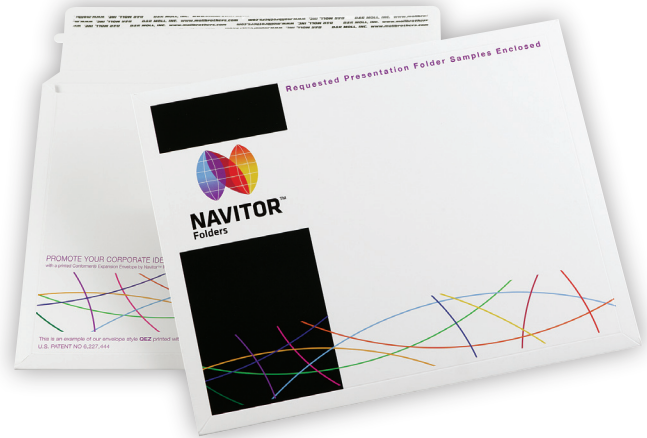

Place a FedEx®, Priority Mail® or UPS® shipping label directly onto your corporate branded Conformer® Expansion Envelope, promoting your corporate identity instead of your courier's.

Conformer® Standard Envelopes

class 1 stocks	smart art code	50	100	250	500	1000	2000	2500	3000	5000
1 standard ink 48hr	1S	\$548.15	622.25	803.95	1055.65	1537.75	2492.90	2969.95	3416.55	5202.95
2 standard inks 48hr	1S	\$669.95	744.05	925.75	1197.75	1713.35	2733.45	3240.95	3712.95	5583.60
1 standard foil stamp* 48hr	1S	\$629.35	706.50	895.30	1156.15	1655.50	2645.15	3139.50	3603.35	5458.75
blind embossing*	1X	\$688.25	760.30	934.90	1174.45	1665.65	2645.15	3139.50	3603.35	5458.75
four color process	4C	\$1490.05	1555.00	1709.30	1958.00	2455.35	3450.05	3947.40	4444.75	6434.15

Please note: the above prices are for class 1 stocks. For all other stocks, please add the prices below. If not specified, raised ink will be used. For more information on Smart Art Codes, visit www.smart-artwork.com. *Price includes up to a 36 square inch die.

Conformer® Legal Envelopes

class 1 stocks	smart art code	50	100	250	500	1000	2000	2500	3000	5000
1 standard ink 48hr	1S	\$565.00	656.00	888.15	1186.55	1766.10	2921.20	3488.60	4035.70	6222.00
2 standard inks 48hr	1S	\$686.80	777.80	1009.95	1328.65	1941.70	3161.75	3759.60	4332.10	6602.65
1 standard foil stamp* 48hr	1S	\$646.20	740.25	979.50	1287.05	1883.85	3073.45	3658.15	4222.50	6477.80
blind embossing*	1X	\$705.10	794.05	1019.10	1305.35	1894.00	3073.45	3658.15	4222.50	6477.80
four color process	4C	not available		\$1745.00	2025.00	2568.00	3660.00	4205.00	4745.00	6904.00

Please note: the above prices are for class 1 stocks. For all other stocks, please add the prices below. If not specified, raised ink will be used. For more information on Smart Art Codes, visit www.smart-artwork.com. *Price includes up to a 36 square inch die.

additional stock options (add charges below to top prices)

	50	100	250	500	1000	2000	2500	3000	5000
class 2 stocks	\$29.40	37.25	53.90	72.55	108.80	182.30	218.55	254.80	399.85
class 3 stocks	\$54.90	62.75	80.40	108.80	166.60	280.30	338.10	394.95	623.30
class 4 stocks	\$76.45	88.20	118.60	166.60	259.70	446.90	541.00	634.10	1003.55
class 5 stocks	\$140.15	166.60	228.35	327.35	503.75	841.85	1008.45	1175.05	1818.90

See page 26 for stock options.

additional options (add charges below to top prices)

	50	100	250	500	1000	2000	2500	3000	5000
tape	\$80.05	80.05	80.05	108.85	166.35	281.40	338.90	396.40	626.50
heavy ink coverage	not available		\$171.90	183.80	207.45	254.85	278.50	302.20	396.95
uv coating	not available		\$171.90	183.80	207.45	254.85	278.50	302.20	396.95
each add'l standard ink color	not available		\$121.80	142.10	175.60	240.55	271.00	296.40	380.65
inside copy (above pockets)	not available		\$118.55	138.75	174.00	236.10	262.00	281.65	360.35
additional foil stamp run*	not available		\$195.20	232.45	306.85	455.60	530.55	604.50	900.80
additional blind emboss run*	not available		\$237.55	257.85	317.00	455.60	530.55	604.50	900.80

(R) Prices effective January, 2009

* price includes up to a 36 square inch die

Production time: 48 hours (ink & foil stamping),
3 working days (embossing), 5 working days (four color process)

Binder Features

- standard binders accommodate 11" x 8½" documents with a ½" tab allowance. custom binders are available upon request.
- **vinyl:** French Calf and Suedene
- **vinyl colors:** warm white, bright white, black, royal blue, red, green, azure blue, gray
- chrome, spine-mounted round rings with boosters are standard.
- rivets are exposed.
- a liner to match your cover material is added for a professional look.
- one or two pockets available for additional charge. Call for quote.

case dimensions

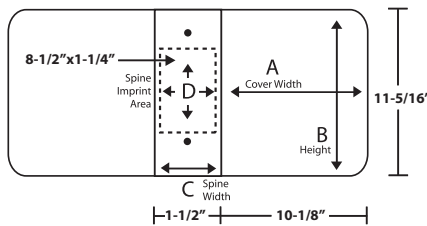

imprint positions

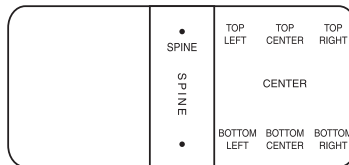

vinyl binders price per piece

	capacity	50	100	250	500	1000
no imprint	1" ring	\$6.50	4.95	4.70	4.55	4.40
	1½" ring	\$6.90	5.45	4.95	4.75	4.60
	2" ring	\$7.75	6.45	5.95	5.65	5.55
1 standard silkscreen color	1" ring	\$9.80	6.75	5.60	5.05	4.75
	1½" ring	\$10.20	7.25	5.85	5.30	4.95
	2" ring	\$11.00	8.25	6.85	6.20	5.90
2 standard silkscreen colors	1" ring	\$13.05	8.60	6.45	5.60	5.10
	1½" ring	\$13.45	9.10	6.70	5.80	5.30
	2" ring	\$14.30	10.10	7.70	6.70	6.25
1 standard foil	1" ring	\$9.20	6.35	5.70	5.25	4.95
	1½" ring	\$9.60	6.85	5.95	5.45	5.15
	2" ring	\$10.45	7.85	6.95	6.35	6.10

(R) Prices effective January, 2009

Production time: 10 working days

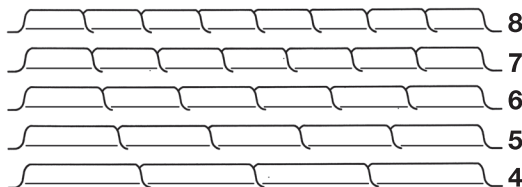
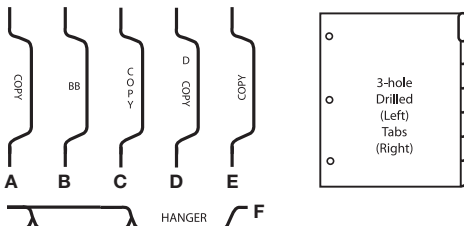

index tabs price per set

	tabs/set	50	100	250	500	1000
black ink	4	\$3.75	2.05	1.45	1.05	.80
black ink	5	\$4.10	2.35	1.65	1.25	1.00
black ink	6	\$4.70	2.65	1.80	1.35	1.20
black ink	7	\$4.95	2.95	2.00	1.60	1.40
black ink	8	\$5.20	3.25	2.15	1.65	1.45

(R) Prices effective January, 2009

Index Tab Features

- **sheet size:** 11" x 8½"
- **stocks:** 90 lb., white index stock with square corners
- tab copy typesetting included in your choice of typestyle. if typestyle is not indicated, Swiss Bold Caps will be used.
- choice of 6 tab copy positions
- maximum of 2 lines of copy per tab, printed on two sides in black ink.
- tabs extend ½" from sheet side
- sheets come with three 5/16" diameter round holes and a 5/8" reinforced binding edge.
- clear or colored mylar (see mylar color options below)
- tabs are packaged uncollated
- reinforced holes with tear-protection edge

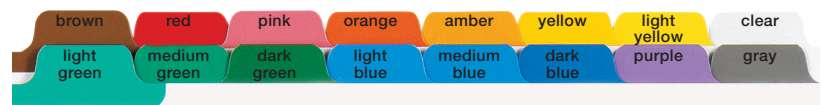

additional options

ink colors (other than black)	\$56.75 (flat charge)
printing on body of tab sheet	\$48.55 (per page)
tabs collated	\$22.25 (per 1000 sheets)
tabs inserted	\$0.60 (per set)

(R) Prices effective January, 2009

Production time: 7 working days

fans

Custom Printed Fan Features

- **stock:** white 18 pt. cover
- **imprint:** flat, 1 or more colors. Four color available.
- **assembly:** included in price. For unassembled fans, call for a quote.
- **custom sizes** are available by quote.

fans price per fan	smart art code	250	500	1000	2500	5000
1 standard ink	1S	\$1.80	0.95	0.85	0.66	0.52
four color process	4C	n/a	\$1.44	1.19	0.98	0.77
black back copy	1S	\$0.25	0.20	0.15	0.10	0.05

(R) Prices effective January, 2009
For more information on Smart Art Codes, visit www.smart-artwork.com.

Production time: 5 working days



8" square



light bulb



stop sign



8"round

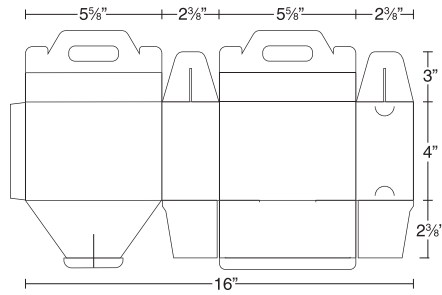

Item Number UF9-PBS
Style PBS

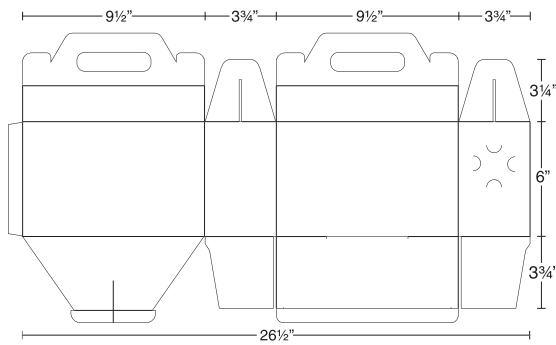

Item Number UF9-PBL
Style PBL

Promotional Packaging Features

- choice of small or large box
- **stock:** low luster white 15 or 18 pt.
- one or two flat ink colors or four color process
- bleeds available at no extra charge
- includes slits for business card placement



Small Box - PBS	smart art code	250	500	1000	2000	3000	5000
1 standard flat ink	1S	\$2.49	1.81	1.02	.71	.61	.51
2 standard flat inks	1S	\$2.84	1.98	1.17	.81	.71	.56
four color process	4C	\$2.94	2.74	1.52	1.02	.86	.81

Large Box - PBL	smart art code	250	500	1000	2000	3000	5000
1 standard flat ink	1S	\$2.94	2.08	1.70	1.47	1.27	1.12
2 standard flat inks	1S	\$3.45	2.33	1.83	1.52	1.37	1.17
four color process	4C	\$6.65	3.35	2.39	1.73	1.48	1.22

(R) Prices effective January, 2009
Price shown is per box. For more information on Smart Art Codes, visit www.smart-artwork.com.

Production time: 5 working days (1 and 2 colors), 10 working days (four color process)

how to order presentation folders

- select a quantity:** Please check if you will or will not accept overruns.
- select an item number:** Include the complete item number.
- select a style:** Select from over 60 standard styles as well as report covers. Ask for quotes on custom designed folder sizes and styles.
- select a folder stock:** Standard paper stocks are available. See swatch book for samples of these stocks. Special order stocks are also available; contact us for a quote.
- send print ready artwork:** For original artwork or a special typestyle not shown, send print ready artwork. See page 37 for electronic artwork guidelines.
- submit a typestyle:** Indicate positioning, point size and font style for typesetting.
- include a drawing:** Include a drawing to show position of logo and type when sending orders to us.

inside copy: Printing inside above pockets requires an extra charge due to the additional press run required. Refer to the price pages for the applicable charges. Additional production time is also required.

pocket copy: When laying out copy for folder pockets, allow additional margin for reinforced edges. Printing ink on folder pockets is not considered inside copy. Foil stamping or embossing on a pocket may require an additional charge. Contact us for a quote.

8. select a printing process:

ink: All inks are available in flat or thermography printing. See page 39 for samples of ink colors. Special ink colors are also available on request for an additional charge; see page 38 for ink charges.

foil stamping or foil embossing: See page 39 for samples of foil colors. Special-order foil colors are available on request. Foils may be flat stamped or sculpted with a process that combines foil stamping and embossing. All foil imprints require the use of a die. There is an additional charge for multiple imprint areas and brass dies; see page 38 for foil embossing and foil stamping.

blind embossing: All stocks may be embossed with a single-level or multi-level, sculpted or debossed image. Embossing/debossing requires the use of a die. There is an additional charge for multiple imprint areas and brass dies; see page 38 for blind embossing.

9. select the position of die cut slits for your business cards, file cards or envelopes:

A) For standard business cards: Horizontal die cut slits for holding business cards are available on all folder styles. Vertical die cut slits for holding business cards are available on all folder styles. Die cuts can be centered on either or both pockets for no additional charge. E and I are only available with half-moon slits. There is an additional charge for off-center business card slits. See page 38 for die cutting.

B) For punch out file cards or slits for file cards: Punch out file cards are available on all folder styles except styles E, I, K, Z, ZF, ZZ and Report Covers. You may order punch out file cards with or without tabs. Please specify left, right or center tab. Also specify which pocket the card should be positioned on. There is an additional charge for die cutting punch out file cards; see page 38 for die cutting.

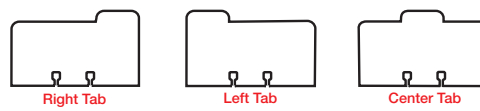

Actual File card size: 4" x 2 3/4"

Horizontal die cut slits for holding standard file cards are available.



C) For envelopes or Post-it® Notes: We have available a 5" slit for a #10 envelope or a 4 1/4" slit for a 4" x 3" Post-it® Note pad. The envelope slit is available on all styles except E, I, K, ZF, Z, ZZ and Report Covers. Post-it® Note slits are available on all styles except E, K, ZF, Z, ZZ and Report Covers. Slits can be positioned on either pocket. Specify a pocket; if not indicated, the slit will be located on the right-hand pocket. Standard positioning is 1" down from the top and centered. There is an additional charge for die cutting; see page 38 for die cutting.

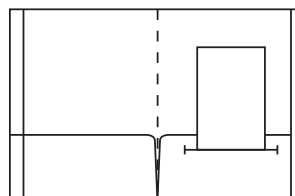

special note: If both ink and foil are required for folder order, use ink pricing for base cost. Add in charges for additional foil stamp run, die cost and extra foil. Ink printed on dark color stocks will discolor.

<p>100 GARFIELD AVENUE NORTH HAVEN, CT 06460 PH: 877.294.5028 • FAX: 877.889.6370 E-MAIL: FOLDERORDERS@NAVITOR.COM</p>		ACCOUNT NUMBER	SHIP DATE (OFFICE USE ONLY)	PARTS
DEALER NAME & ADDRESS		PURCHASE ORDER NUMBER	DATE RECEIVED	CAT
ESTIMATE NUMBER		PLEASE ENCLOSE		SOURCE
<input type="checkbox"/> NEW ORDER <input type="checkbox"/> EXACT REORDER <input type="checkbox"/> REORDER WITH CHANGES		<input type="checkbox"/> EXTRA ORDER BLANKS <input type="checkbox"/> ADDITIONAL CATALOGS		
CREDIT CARD INFORMATION		EXP. DATE: _____ / _____		
ORDER INFORMATION QUANTITY: _____ <input type="checkbox"/> WILL ACCEPT UP TO 10% OVER RUN <input type="checkbox"/> WILL NOT ACCEPT OVER RUN ITEM NUMBER: _____ STYLE OF FOLDER: _____ STOCK (TYPE & COLOR): _____		ARTWORK <input type="checkbox"/> ARTWORK WAS EMAILED <input type="checkbox"/> CENTER IN ALL DIRECTIONS <input type="checkbox"/> FOLLOW SAMPLE / MOCK-UP <input type="checkbox"/> USE ARTWORK AS IS		PROOFS <input type="checkbox"/> BLACK AND WHITE PROOF <input type="checkbox"/> COLOR PROOF <input type="checkbox"/> FAX _____ <input type="checkbox"/> EMAIL _____ <input type="checkbox"/> MAIL _____
PRINTING PROCESS <input type="checkbox"/> FIRST SIDE INCLUDES FRONT COVER, BACK COVER, POCKET(S), & REINFORCED EDGE TABS <input type="checkbox"/> SECOND SIDE INCLUDES INSIDE ABOVE THE POCKETS <input type="checkbox"/> FLAT <input type="checkbox"/> THERMOGRAPHY <input type="checkbox"/> HEAVY COVERAGE <input type="checkbox"/> STANDARD _____ <input type="checkbox"/> STANDARD _____ <input type="checkbox"/> PMS _____ <input type="checkbox"/> PMS _____ <input type="checkbox"/> FOUR COLOR PROCESS <input type="checkbox"/> FOUR COLOR PROCESS				
BRASS DIE <input type="checkbox"/> FOIL EMBOSSED MULTI-LEVEL DIE FOIL COLOR: _____ <input type="checkbox"/> BLIND EMBOSSED MULTI-LEVEL DIE		CONVERSION <input type="checkbox"/> FOIL STAMPED FLAT <input type="checkbox"/> FOIL STAMPED EMBOSSED FOIL COLOR: _____ <input type="checkbox"/> BLIND EMBOSSED SINGLE-LEVEL DIE		FINISHING PROCESSES <input type="checkbox"/> VARNISH <input type="checkbox"/> UV COATING (FOUR COLOR PROCESS ONLY) <input type="checkbox"/> LAMINATION
9 POCKETS & BUSINESS CARD SLITS <input type="checkbox"/> POCKET <input type="checkbox"/> RIGHT <input type="checkbox"/> LEFT <input type="checkbox"/> BOTH <input type="checkbox"/> BUSINESS CARD SLITS <input type="checkbox"/> NONE <input type="checkbox"/> HORIZONTAL <input type="checkbox"/> VERTICAL OTHER SLITS: _____		6 SPECIAL INSTRUCTIONS _____ _____ _____		
7 FOLDER LAYOUT 		SHIPPING SHIPPING METHOD (STANDARD IS GROUND SERVICE) DROP SHIP ADDRESS (ADDITIONAL CHARGE) _____ _____		OFFICE USE ONLY ATTACH BILLING LABEL HERE

Smart Artwork Codes:

For a glossary of terms and codes, visit www.smart-artwork.com.

NATIVE APPLICATIONS

We accept files created in the following native applications:



Acrobat PDF®..... Mac and PC
 QuarkXpress®..... Mac and PC
 Adobe InDesign®..... Mac and PC
 Adobe Photoshop®..... Mac and PC
 Adobe Illustrator®..... Mac and PC
 CorelDRAW®..... PC only

We do not accept files created in the following native applications:

PowerPoint®..... Mac and PC
 Excel®..... Mac and PC
 Word®..... Mac and PC
 Publisher®..... Mac and PC

APPLICATION REQUIREMENTS

PDFs — Macintosh or IBM Compatible

1. All fonts must be embedded.
2. All elements of the file must be colored per our guidelines.
3. All placed graphics and images need to be high quality, colored according to our guidelines (at right) for the product ordered. Whenever possible, place vector images into the layout before converting to a PDF. Please be aware that when changes need to be made to placed images (coloring, mode, etc.), there is the possibility of the quality being compromised.
4. Please name the PDFs without punctuation of any kind (except .pdf) or special characters. File names should be short.

QuarkXPress® — Macintosh or IBM Compatible

1. When selecting fonts, you must use only the selected fonts owned by Navitor®, as listed on Navitor.com. If you are using fonts not owned by Navitor, outlines must be created in an illustration program before placing into your QuarkXPress® document.
2. Never use the style palette to modify fonts. It will not hold when printed.
3. Along with your file sent for placement, we need the supporting graphic file(s) given the same name as the graphic(s) in your document. (Changing the name after placement will make the graphic come up as "missing" or "modified" when read by our imagesetters.) Place graphics at 100%. Placed graphics need to be high quality or good vector art to receive the best quality printed product.
4. Color all text and graphics according to the enclosed color specifications (at right) for the type of product you are ordering.

Adobe® InDesign® — Macintosh or IBM Compatible

1. Change all text into "outlines" in your document.
2. If you are using an imported graphic in your InDesign® document, be sure to include or embed the original graphic file. Place graphics at 100%. Placed graphics need to be high quality or good vector art to receive the best quality printed product.
3. Save as an INDD file.
4. Color all text and graphics according to the enclosed color specifications (on reverse) for the type of product you are ordering.

Adobe® Photoshop®

1. Files must be saved as a TIFF without compression.
2. Do not color an image in Photoshop® (for spot printing).
3. Please submit black and white bitmap mode images at 600 dpi and grayscale mode images at 600 dpi for standard spot printing or Multicolor Inks. For full color printed folders, CMYK images need to be submitted at 300 dpi. Images that come to Navitor at a lower quality than what is recommended will be output as sent.
4. Color all text and graphics according to the enclosed color specifications (at right) for the type of product you are ordering.
5. All files need to be submitted at the size being used for printing.
6. If bleeds are needed, allow 1/8" (.125") on all sides.

Adobe® Illustrator® — Macintosh or IBM Compatible

1. Change all text into "outlines" in your document.
2. If you are using an imported graphic in your Illustrator® document, be sure to include or embed the original graphic file. Place graphics at 100%. Placed graphics need to be high quality or good vector art to receive the best quality printed product.
3. Save the file as an Illustrator EPS.
4. Color all text and graphics according to the enclosed color specifications (at right) for the type of product you are ordering.

CorelDRAW® — (native files version 12 and lower)

1. We do not recommend this application for full color layouts.
2. If CorelDraw is used, we cannot guarantee that colors for full color products will match what is seen on screen. You will be responsible for any color issues if native CorelDraw file is sent.
3. Follow established guidelines for all graphics. Placed graphics need to be colored correctly for the product ordered (at right). Placed graphics need to be high quality or good vector art to receive the best quality printed product.
4. Create outlines (text to curves) on all type within a native CorelDRAW file.
5. If there are text overflow issues, Navitor may need to resize or reposition text to fit the imprint area.
6. Color all text according to the enclosed color specifications (at right).

CREATING YOUR FILES

Create one item sized correctly per document. (Placed graphics and text should be sized at 100%).

Fonts:

Using your illustration program, convert all text "to curves" or "create outlines" in your files. Never use the stylization palette to bold, italicize, add drop shadow to or put outline on your fonts. If you are using fonts not owned by Navitor, outlines must be created in an illustration program before submitting your artwork.

Margin Requirements:

Spot Color printing (one or more spot colors): artwork must have the position noted in the special instructions, or a sample must be attached. Four color process printing should have at least 1/8" (.125") margins.

Bleed Requirements:

1. 1/8" (.125") should be allowed on all sides. Please make sure the text still maintains the required margin even when graphics bleed.

Color Requirements:

Navitor now has a new "Accurate Color" system. To our channel partners - you can now send your files colored the intended PMS color versus having to color it CMYK. Every effort will be made to print your intended color within acceptable standards.

Spot Color Printing:

1. Please submit black and white bitmap mode images at 600 dpi and grayscale mode images at 600 dpi for standard spot printing.

Four Color Process Printing:

1. Every element of the file must be colored with process CMYK colors (no RGB, indexed color, etc.).
2. Pantone® colors - While we are often able to closely reproduce a spot PMS® ink using four color process, PMS® spot colors and process colors are produced using different methods. Therefore, colors produced in four color will differ from Pantone® spot colors, sometimes significantly. Please refer to a Solid to Process Color Imaging Guide for color conversions.

Multicolor Printing:

1. Every element of the file must be colored according to the Multicolor color mix chart (visit Navitor.com) or it may be necessary for us to question the color correctness, which would delay your order.
2. If the CMYK mixes used in your file do not match the Multicolor numbers chosen, we will use the file as is and print as a "CMYK Scan" with no guarantees.

PRINTING BLACK VS. BLACK For Four Color and Multicolor Orders

Use printing black (C-80%, M-80%, Y-80%, K-95%) instead of 100% black when in registration with other colors, in areas with heavy ink coverage, and for bold type or lines (2.5 points or thicker). Use 100% black in all other instances. If the CMYK mixes used in your file do not match the Multicolor numbers chosen, we will use the file as is and print as a "CMYK Scan" with no guarantees.

HOW TO COLOR YOUR FILES FOR SPOT COLOR PRINTING

One Color Imprint:

<i>If ink colors desired are:</i>	<i>Use these colors:</i>
Black	Black
Red	Red
Light Blue	Light Blue
Brown	Brown
Green	Green
Burgundy	Burgundy
Gray	Gray
Dark Blue	Dark Blue
Teal	Teal
PMS Ink	New (see color requirements above)
Any color not shown	Black
Any foil or embossing	Conversion (crucial for die ordering)

Two or More Color Imprint:

<i>If ink color desired is:</i>	<i>Use this color:</i>
Black & Light Blue	Black & Light Blue
Dark Blue & Red	Dark Blue & Red
Black & Red	Black & Red
Black & Brown	Black & Brown
Black & Dark Blue	Black & Dark Blue
Light Blue & Red	Light Blue & Red
Black & Burgundy	Black & Burgundy
Any 2 Std. not shown	The Actual Color
Black & 1 PMS Ink	Color Spot Pantone Colors*
2 PMS Inks	Spot Pantone Colors*
1 Standard & 1 PMS	Standard & Spot Pantone Colors*
Black & Foil	Black & Conversion
Black & Embossing	Black & Conversion

* When using a Spot Pantone® Color in your file, it needs to be named and colored the actual Pantone® name and number being used to print your order.

IMPORTANT!

Please indicate your color separations on your order blank.

SUBMITTING YOUR FILES

1. Once your files have been set up according to these guidelines, give them to your business partner to submit to Navitor.
2. We can accept your files on 3.5" floppy disks, 100MB Zip disks, CD-Rs, DVDs or online at Navitor.com.
3. DO NOT send us the only copy of your file. The disk or file could possibly be lost or damaged in the mail. A copy of the original is preferred.
4. We reserve the right to use all products in our advertising and displays unless otherwise specified in writing at the time of the order.

Please visit Navitor.com for further information on submitting files.

Pantone®, PMS and Pantone Matching System® are Pantone Inc.'s check-standard trademark for color reproduction and color reproduction materials.

Folder orders are produced at Navitor Midwest.

special services

art charges: If your layout requires special attention or your artwork is unsuitable for reproduction, we will make the necessary changes. You will be notified if the charges will exceed \$25.00 NET.

changes or cancellations: Changes to orders in progress may require additional charges and/or time. Cancellations after an order is in progress will require payment for work completed.

die cutting: You may provide a die cutting die for reorders. Various special die cuts, including punch-out file card, off center business card slits, envelope slits, Post-it® Note pad slits and 2" x 4" window are available for a special die cut charge.

die charges: There is an additional charge for a standard 5" envelope slit, 4 1/4" Post-it® Note pad slit, standard 2" x 4" size window or standard file card punch out dies. All other special die cut dies will require an additional die charge. The cost will vary according to the size and amount of detail in your design. Call or send design for a price quote. Allow 10 working days. For orders shipping direct, dies are returned to the dealer for a direct shipping cost.

duotones: Two screened ink colors printed on top of each other.

engraving: This process is available with folders. Call for more information and pricing.

FasTurn® folders: 24hr production example: if order is received Monday by Noon CST, order ships on Tuesday. Prices and production time based on sending print ready artwork. Dies are recycled and not returned. Ink and foil colors are available only as shown. Please indicate style UF9-FN-2 on your order. *Any changes or alterations to FasTurn® features, standard pricing will apply.*

final folding: Orders are shipped with folders open. If folders need to be folded in half when they are shipped, additional charges will apply. Contact us for pricing.

laminating: Call for pricing and availability. Allow an additional 5 working days.

over/under runs: All presentation folder orders are subject to a 10% over run or under run.

proofs PDF: Black and white, and Color Oris proofs are available. Oris proofs are for four color process only, colors may not be exact. Add 2 working days to the production time when requesting a proof. Printed press proofs are billed as actual orders of the minimum quantity less 10%.

rush orders: If production schedule allows, charges for rush orders are based on time constraints and complexity of the order. Contact us for availability and pricing.

third party shipping: additional charge apply. contact us for pricing.

foil and embossing

die handling: You may provide a blind embossing, die cutting, foil embossing or foil stamping die for re-orders (additional charges will apply).

die types: Various types of dies are available. Use the following guidelines to select your die. See blind embossing, die cutting, foil embossing and foil stamping to determine the appropriate die charge. Foil stamping and embossing dies are not returned.

copper dies: These single level dies are used for foil stamping and blind embossing. Copper dies provide crisp quality without the expense of a brass die.

brass dies: These single or multi-level sculpted dies are used for blind embossing or foil embossing. These dies produce a deep, crisp image with well-defined edges. Note: Fine lines and type do not foil emboss well. Fax or mail artwork for a price quote.

foil charges: Special foil colors are available. Call for a quote. If foil area exceeds 36 square inches there will be an extra foil charge. Please call for a quote. All foil imprints require the use of a die (see die types).

foil embossing: This is a process that combines foil stamping and embossing into one press run. A brass die is required for this process. Fax or mail artwork for a price quote.

foil stamping or blind embossing: Orders with one area of foil stamping or blind embossing up to 36 square inches, there is no additional charge for the die. Orders with areas larger than 36 square inches, call or send artwork for a price quote due to extra foil charges. Charges for dies vary according to the size and amount of detail in your design. We will notify you of any additional costs before processing your order. Send actual sized artwork or a sample for an estimated die charge.

additional die set-up: If more than one die is used, an additional die setup charge and die charge is needed.

pocket copy: Foil stamping or embossing on a pocket may require an additional charge. Call or write for a price quote.

registration: Registration is when two or more ink and/or foil colors touch or when there is no tolerance for movement. Registration charges apply when multiple ink, foil or embossing areas are printed 1/4" or less apart or touch. Raised inks cannot register with flat inks, blind embossing, die cutting, foil embossing or foil stamping.

foil/emboss guide: Foil and emboss areas are produced using a die. Die costs are figured by the size and amount of detail of the die. The checklist below will step you through figuring out your die size. We used the example of foil in the sample below, but the same can apply to embossing.

✓ How many areas of foil or emboss? If there is a 3 1/2" space in between the areas of foil, then each foil area is a separate die charge, and an additional die set-up charge will also apply.

✓ Measure the height and width of the foil area.
Example: 2" x 2" = 4 square inches

✓ Figure the die size for each area. There are additional die set-up and die charge for orders with more than one foil or emboss area.

examples

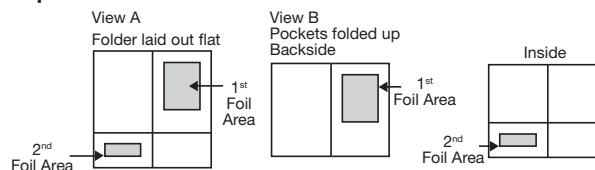

four color process

four color process: The pricing for four color process printing includes four process ink colors.

color matching: Industry standard ink densities are used for both PMS® and four color process. If color matching is needed, it must be clarified and approved before production begins.

UV coating: This ultra violet process is available with four color process only.

ink

heavy ink coverage: Any solid or screened areas exceeding 15% of the front or back cover (4" x 4" area) must be flat printed. Any solid areas exceeding 45% (7" x 7" area) of the front or back cover will require the heavy ink coverage add on price. In-shop time is 7 days for three or more inks and for two-sided work. Heavy metallic ink not available.

inside copy: Printing inside above pockets requires an extra charge due to the additional press run required. Please refer to the price pages for the applicable charges. Additional production time is also required.

pocket copy: When laying out copy for folder pockets, allow 7/8" additional margin for reinforced edges. Printing ink on folder pockets is not considered inside copy.

screens: A screen is a dot pattern of a solid ink color that makes that color look lighter. For example, when red is screened it looks pink. There is no additional charge for screens. Standard screen percentage is 20%, which will be used unless otherwise indicated. We use 120 line screen. Foil is not available screened.

special ink: Special inks are available per color by selecting from the PANTONE® Color Formula Guide. Requesting an exact match from a color swatch or sample will require an additional color match charge.

standard inks: All standard inks are translucent inks. We do not recommend printing ink on dark colored stocks due to the ink discoloring. A no-charge reprint is not available when printing inks on dark colored stocks.

thermography: No additional charge for folders printed in thermography. Legal folders, card carriers, tri-fold folders, Conformer® envelopes, file jackets, vertical pocket folders, and style BF8 cannot be printed in thermography. Large imprint areas are not recommended and will be flat printed. Thermography cannot register with flat inks, blind embossing, die cutting, foil embossing or foil stamping.

production times

Production begins when artwork files have been approved

- 1 or 2 ink colors **24hr**
- flat foil stamping **24hr**
- blind embossing 3 working days
- four color process 5 working days
- heavy ink coverage* 7 working days

*up to 5,000 quantity refer to page 38 for additional special services and descriptions

special charges

- additional die setup: \$41.65
- artwork: \$25.00 NET
(necessary changes to make file print ready)
- color match: (per color) \$58.35
- die cutting
 - die set-up \$50.00 NET
 - special die cuts (first 1000) \$91.75
- direct shipping die returns \$10.00 NET
- proofs
 - black & white proof \$16.65
 - color oris proof (four color only) \$65.00 NET
 - press proof Min. Qty, Less 10%
- registration
 - blind emboss & foil (first 1000) \$39.40
 - two foil colors (first 1000) \$39.40
 - flat ink & foil \$137.70
 - flat ink & blind emboss \$137.70
 - two inks FREE
 - three or more flat inks \$137.70
- special inks (per color) \$58.35

standard foil colors*



standard ink colors*



Inks available in flat or thermography/raised print. If not specified, thermography/raised print will be used. *Colors shown are close representation. Exact color will vary.

standard cover stocks

uncoated, coated & fiber

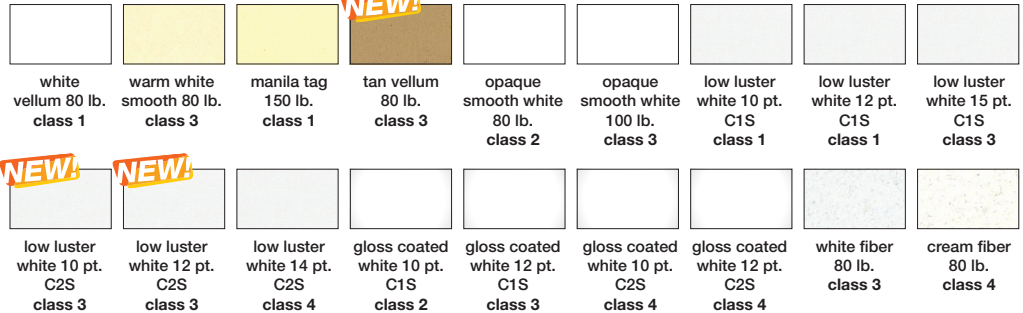

laid, felt & environment®



colored gloss, linen & leatherette



folder options

- over 50 styles
- 50+ stocks
- four color process
- uv coating
- foil stamping
- thermography and flat ink
- final folding
- embossing
- laminating

folder applications

- sales presentations
- tradeshow handouts
- orientation packets
- price listings
- employee benefit packets
- new member packets
- service listing
- direct mail campaigns



Distributed by: