

presentation folders



NAVITOR[®]
Smart Printing. Smart Business.

FasTurn® folders	4-5
standard & specialty folders	6-7
oversized & expandable folders	8
file folders	9
NEW! business card perforated folders	10
legal folders	11
report covers	12-13
small folders	14-15
vertical pocket & NEW! landscape folders	16
tri-fold folders	17
loose pocket folders	18
multicolor folders	19
certificate holders	20
photo holders	21
card carriers	22
NEW! multimedia holders	23
NEW! paper portfolios	24
poly folders & portfolios	25
conformer® envelopes & portfolios	26
binders & index tabs	27
stepped & stitched inserts	28-29
custom cube holders	30
promotional packaging	31
custom options	32
electronic guidelines	33
general information	34
stocks, inks, foils & foil patterns	35

Welcome.

Your reputation is everything and our commitment to this philosophy brings...

- 1 service and simplification**
We are committed to not only helping you with your order, but also building a strategic relationship with you. We have simplified pricing with no set-up fees and no bleed or registration charges.
- 2 fast turnaround**
Fast folders should be a right, not a privilege. We offer 24 hour service on over 80% of our standards product offerings. Over 50% of our orders are shipped prior to the expected date and 99% of our orders ship on time.
- 3 over run commitment: your choice, not our policy**
We will call you before shipping overages. There is no charge for requesting exact quantity.
- 4 breakthrough printing**
Our gains in efficiency and drive for innovation have lead us to our new screened and textured foil options as well as product offerings with variable data.
- 5 sustainability**
We offer a variety of environmentally friendly stocks, use UV inks for flat printing, and recycle our foil and embossing dies as well as any stock that does not result in a final quality product.

production times

Production begins when artwork files have been approved

1 or 2 ink colors	24hr
1 foil stamping	24hr
blind embossing	3 working days
four color process	5 working days
heavy ink coverage*	6 working days

*up to 5,000 quantity; refer to page 34 for additional special services and descriptions

how to order your presentation folder in 6 easy steps!

1] select your style and quantity

Choose from over 60 standard styles or call for a custom quote.

2] select your stock type and color

Over 50 standard paper stocks are available. See page 35 for all samples.

3] select a business card slit option

a) Standard Business Card Slit options include: Horizontal, Vertical and Universal Half Moon.

b) Slits can be centered on either the right, left or both pockets for no additional charge.

4] select an imprint process

a) All standard inks are available in flat and thermography printing.

b) Foils may be flat, embossed or textured.

5] send print ready artwork

See page 33 for electronic guidelines.

6] indicate any special instructions

These include type style, point size and positioning.

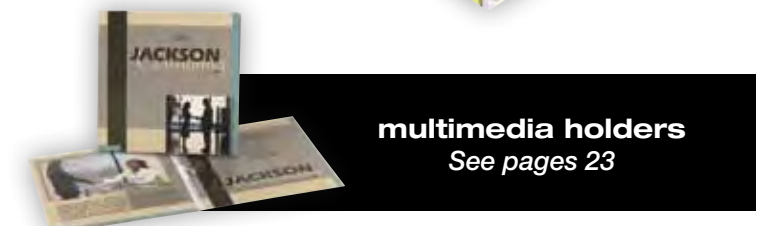

FasTurn® 24 hour folders



24hr SERVICE

- one easy price means no extra charges or setup costs.
- standard ground shipping within the continental U.S. is included in the FasTurn® pricing listed below.

features:

- available on our most popular style (shown below) with standard horizontal business card slits centered on the right pocket.

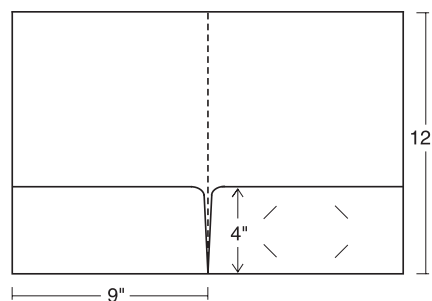

Item Number FLDR-FN224

- choose one of the following printing options:

one or two flat inks

50% coverage, one side - outside and pockets; image size up to 144* square inches. No flood coating.

one or two thermography inks

one image area up to 32 square inches.

one color foil stamping

one image area up to 32* square inches.

***increased imprint area!**

- bleeds are not available with thermography raised ink.
- please indicate item number FLDR-FN224 on your order blank.
- prices based on receiving print ready art.

order FasTurn® folders online!
www.corpez.com/navfolders

FasTurn® 24 hour folders

	smart art code	50	100	200	250	500	1000
no imprint	-	\$139.80	177.05	247.45	279.55	440.00	760.00
1 standard ink (below)	1S	\$161.55	209.15	289.90	328.20	515.60	889.60
2 standard inks (below)	1S	\$209.15	274.35	355.15	392.40	579.80	953.80
1 standard foil stamp (below)	1S	\$203.95	252.65	333.40	370.65	558.05	932.05

(R) Prices effective January, 2010

For more information on Smart Art Codes, visit www.smart-artwork.com.

Production time: 24 hours

foil colors



ink colors

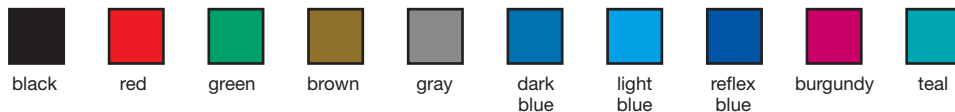

stock selection



10 pt. white high gloss

hunter green felt*

black linen*

burgundy linen*

bright white linen

warm white linen

gray linen

navy blue linen*

12 pt. white low luster

white matte smooth

NOTE: Inks, foils and stocks are close representations. Exact color may vary.

*Dark stocks available only with foil stamping.

FasTurn® 48 hour folders

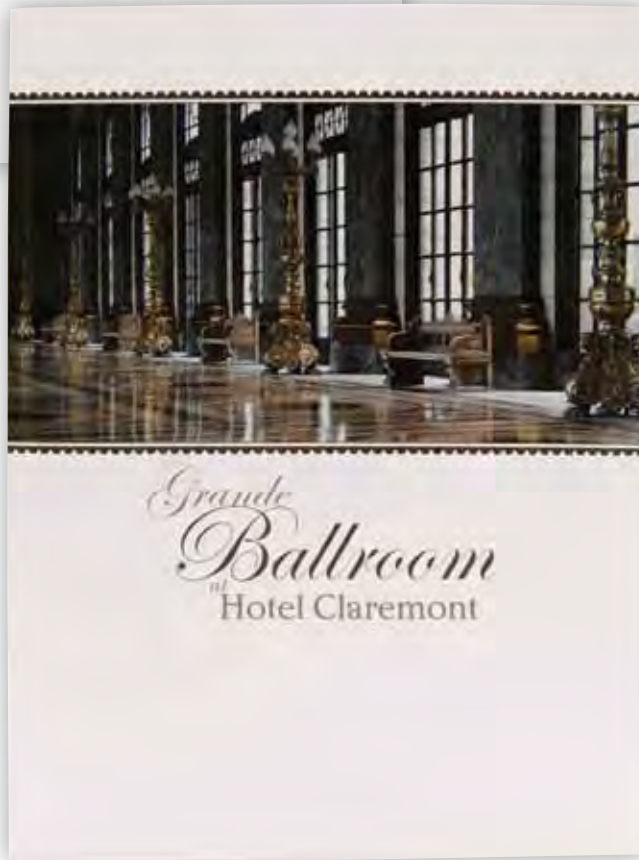

48hr SERVICE

- one easy price means no extra charges or setup costs.
- standard ground shipping within the continental U.S. is included in the FasTurn® pricing listed below.

features:

- available on our most popular style (shown below) with standard horizontal business card slits centered on the right pocket.

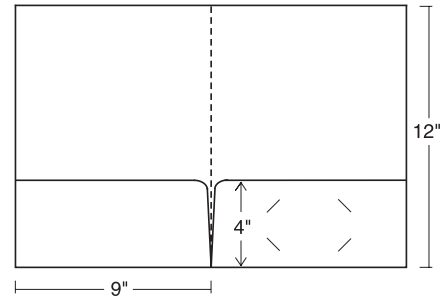

Item Number **FLDR-FN248**

- up to 50% coverage on one side- includes outside and pockets; image size up to 144 square inches.
- please indicate item number FLDR-FN248 on your order blank.
- prices based on receiving print ready art.

FasTurn® 48 hour folders

	smart art code	50	100	200	250	500	1000
4 color process	4C	\$323.05	436.90	651.20	752.70	1172.00	1415.30

(R) Prices effective January, 2010

For more information on Smart Art Codes, visit www.smart-artwork.com.

Production time: 48 hours

stock selection



10 pt. white high gloss bright white linen 12 pt. white low luster white matte smooth warm white linen

For quantities not shown, please call for quote.

standard & specialty folders

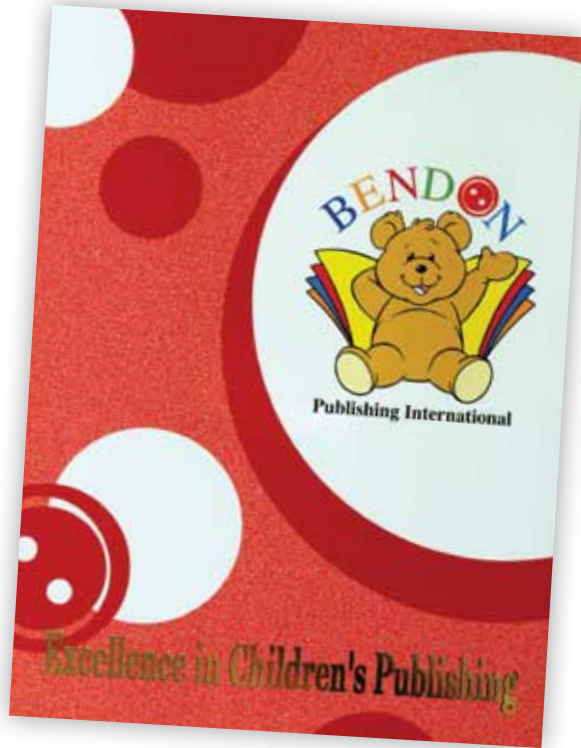

standard & specialty folders

class 1 stocks	smart art code	50	100	250	500	1000	2000
no imprint 24hr	-	\$174.30	223.50	368.05	565.95	928.80	1500.85
1 standard ink 24hr	1S	\$227.70	296.30	478.80	691.00	1082.60	1703.85
2 standard inks 24hr	1S	\$350.65	419.35	601.80	834.55	1259.95	1946.85
1 standard foil stamp* 24hr	1S	\$306.55	377.65	565.40	784.65	1189.60	1839.25
blind embossing*	1X	\$365.45	431.45	605.00	802.95	1199.75	1839.25
four color process	4C	\$812.00	880.70	1063.15	1295.90	1721.30	2408.20

(R) Prices effective January, 2010

Please note: the above prices are for class 1 stocks. For all other stocks, please add the prices found on page 35. For more information on Smart Art Codes, visit www.smart-artwork.com. *Price includes 2 dies totaling up to 36 square inches.

additional options (add charges below to top prices)

	50	100	250	500	1000	2000
Conformer® Expansion Pocket (2 pockets)	\$31.30	38.55	57.70	80.05	121.35	187.65
heavy ink coverage	-----not available -----		\$175.35	187.45	211.60	259.95
uv coating	-----not available -----		\$175.35	187.45	211.60	259.95
each add'l standard ink color	-----not available -----		\$172.45	193.15	227.35	293.60
inside copy (above pockets)	-----not available -----		\$120.95	141.55	177.45	240.85
additional foil stamp run*	-----not available -----		\$247.30	285.30	361.20	512.90
additional blind emboss run*	-----not available -----		\$290.50	311.20	371.55	512.90

(R)

*Price includes 2 dies totaling up to 36 square inches.

Production time: 24 hours (ink or foil stamping), 3 working days (embossing), 5 working days (four color process)

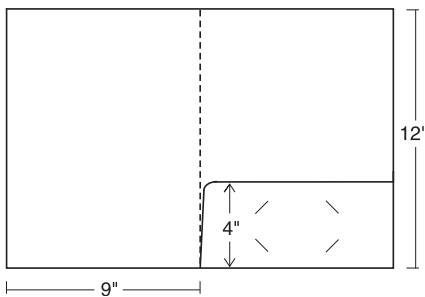

Item Number FLDR-F1

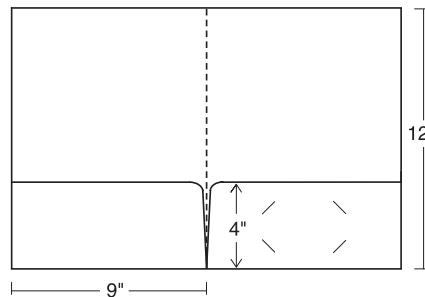

Item Number FLDR-F2

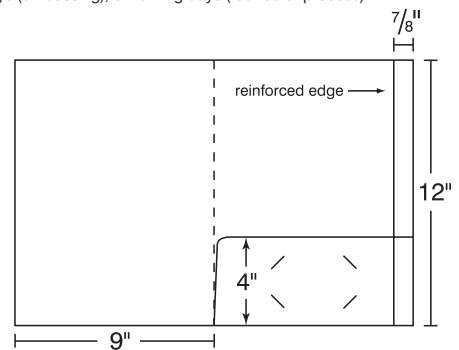

Item Number FLDR-B1

standard & specialty folders

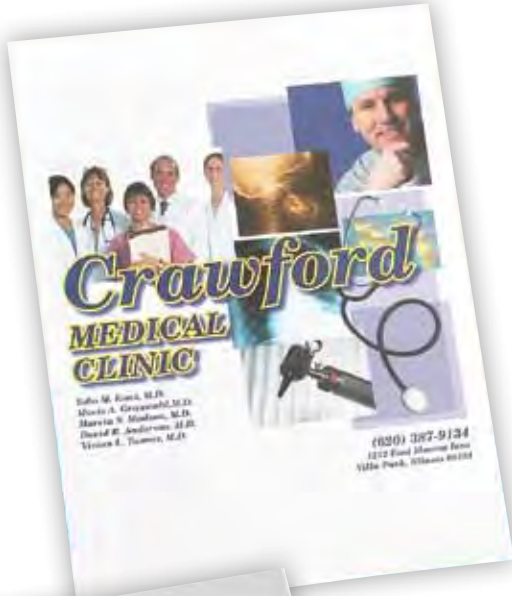

folders present a great opportunity in the healthcare market! ideas include:

- new patient kits
- in-room materials
- pre- & post-care instructions
- insurance paperwork
- new baby kits
- laboratory charts

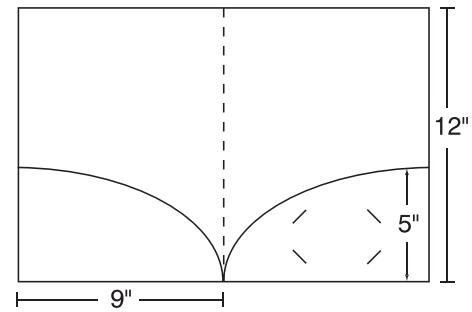

Item Number FLDR-N1 (1 pocket)
Item Number FLDR-N2 (2 pockets)

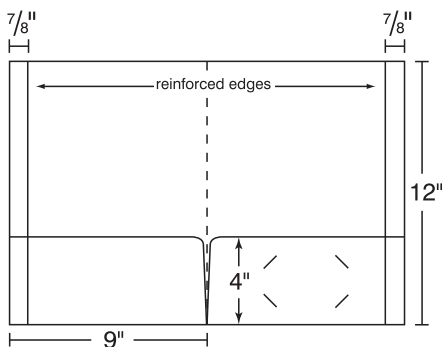

Item Number FLDR-B2

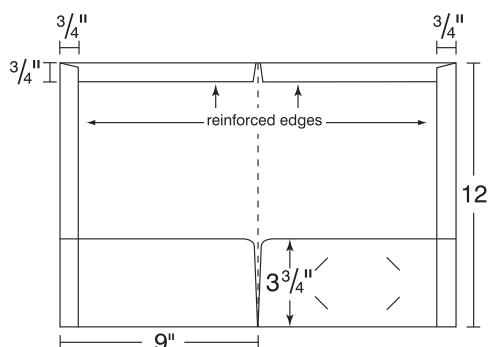

Item Number FLDR-TR2

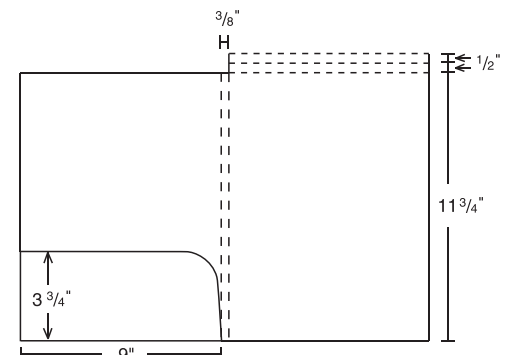

Item Number FLDR-BF8

For quantities not shown, please call for quote.

oversized & expandable folders



see pricing on page 6



Thicker materials like booklets and catalogs fit perfectly in our roomier Conformer® Folder Style Q-2. See Additional Options for Conformer® Pocket pricing.

U.S. patent number is required to print on all Conformer® Products: 6,116,651 Conformer® Folder • 6,227,444 Conformer® Envelope. Conformer® is a registered trademark of CONFORMER PRODUCTS, INC.

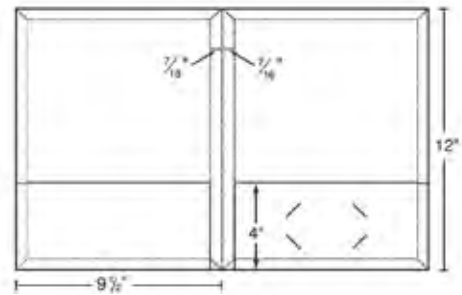

Conformer® Folder
Item Number FLDR-Q2

See page 6 for upcharge pricing.

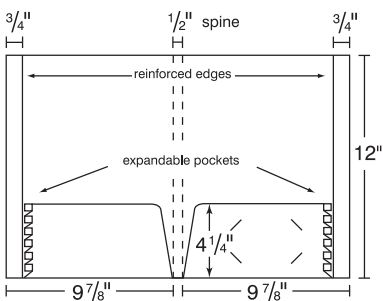

Item Number FLDR-G2
Holds 100 sheets (50 in each pocket)

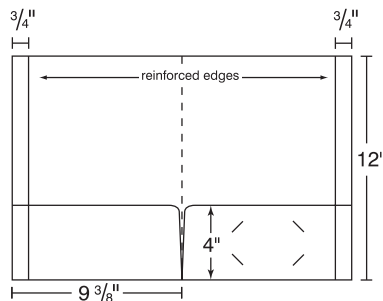

Item Number FLDR-J1 (1 pocket)
Item Number FLDR-J2 (2 pockets)

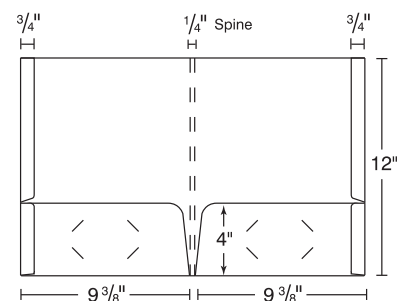

Item Number FLDR-H2
Holds 50 sheets (25 in each pocket)

NEW!

3 tab file folders (no pockets)

class 1 stocks	smart art code	50	100	250	500	1000	2000
no imprint 24hr	-	\$265.60	421.20	798.85	1331.65	2301.70	3794.45
1 standard ink 24hr	1S	\$421.00	633.05	1121.15	1695.70	2749.25	4385.20
2 standard inks 24hr	1S	\$778.80	991.10	1479.10	2113.40	3265.35	5092.35
1 standard foil stamp* 24hr	1S	\$650.45	869.75	1373.15	1968.20	3060.60	4779.20
blind embossing*	1X	\$821.85	1026.35	1488.40	2021.45	3090.15	4779.20
four color process	4C	\$2121.30	2333.65	2821.60	3455.95	4607.85	6434.85

(R) Prices effective January, 2010

Please note: the above prices are for class 1 stocks. For all other stocks, please add the prices found on page 35. For more information on Smart Art Codes, visit www.smart-artwork.com. *Price includes 2 dies totaling up to 36 square inches. Call for quote on individual tabbed pricing.

NEW!

5 tab file folders (no pockets)

class 1 stocks	smart art code	50	100	250	500	1000	2000
no imprint 24hr	-	\$433.55	687.50	1303.95	2173.60	3757.05	6193.70
1 standard ink 24hr	1S	\$687.20	1033.30	1830.05	2767.85	4487.60	7157.95
2 standard inks 24hr	1S	\$1271.20	1617.80	2414.30	3449.70	5330.00	8312.20
1 standard foil stamp* 24hr	1S	\$1061.70	1419.70	2241.40	3212.70	4995.85	7801.10
blind embossing*	1X	\$1341.50	1675.25	2429.50	3299.60	5044.05	7801.10
four color process	4C	\$3462.60	3809.20	4605.70	5641.10	7521.40	10503.60

(R) Prices effective January, 2010

Please note: the above prices are for class 1 stocks. For all other stocks, please add the prices found on page 35. For more information on Smart Art Codes, visit www.smart-artwork.com. *Price includes 2 dies totaling up to 36 square inches. Call for quote on individual tabbed pricing.

Production time: 24 hours (ink or foil stamping),
3 working days (embossing)
5 working days (four color process)

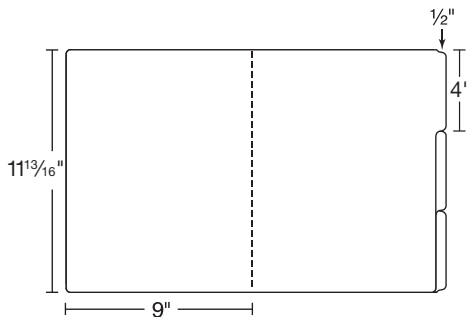

Item Number FLDR-TS3

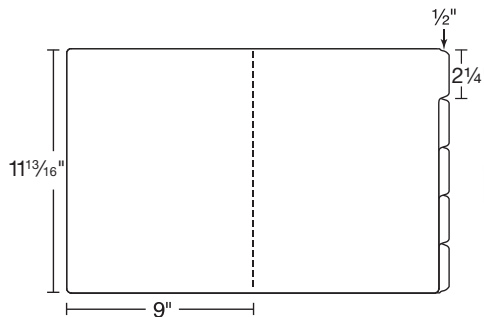

Item Number FLDR-TS5



for styles shown below, see page 6 for pricing

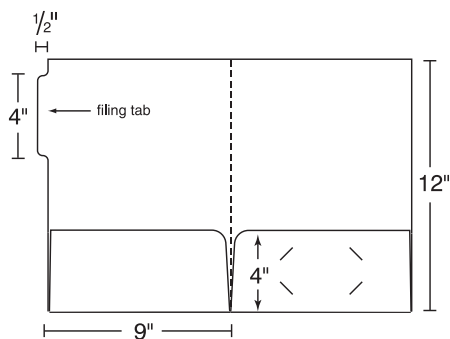

Item Number FLDR-F2T

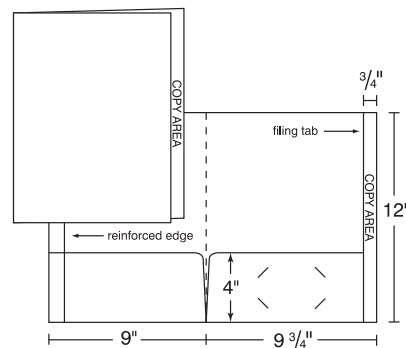

Item Number FLDR-C1 (1 pocket)
Item Number FLDR-C2 (2 pockets)

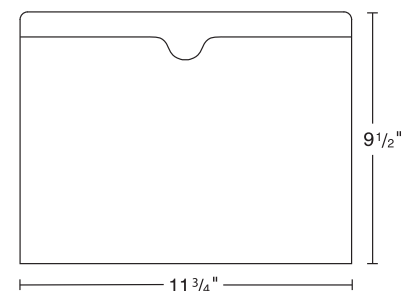

Item Number FLDR-FJ

For quantities not shown, please call for quote.

business card perforated folders

business card perforated folders

Prepare your presentation with ease! Collate materials & tear the FREE personalized business card off in an instant. No separate order necessary!

NEW!



business card perforated folders

class 1 stocks	smart art code	50	100	250	500	1000	2000
1 standard ink 24hr	1S	\$211.80	275.60	445.30	642.65	1006.85	1584.60
2 standard inks 24hr	1S	\$326.10	390.00	559.70	776.15	1171.75	1810.60
1 standard foil stamp* 24hr	1S	\$285.10	351.25	525.85	729.75	1106.35	1710.50
blind embossing*	1X	\$339.90	401.25	562.65	746.75	1115.80	1710.50
four color process	4C	\$755.20	819.05	988.75	1205.20	1600.85	2239.65

(R) Prices effective January, 2010

Please note: the above prices are for class 1 stocks. For all other stocks, please add the prices found on page 35. For more information on Smart Art Codes, visit www.smart-artwork.com. *Price includes 2 dies totaling up to 36 square inches.

additional options (add charges below to top prices)

	50	100	250	500	1000	2000
heavy ink coverage	-----not available -----	-----not available -----	\$175.35	187.45	211.60	259.95
uv coating	-----not available -----	-----not available -----	\$175.35	187.45	211.60	259.95
each add'l standard ink color	-----not available -----	-----not available -----	\$172.45	193.15	227.35	293.60
inside copy (above pockets)	-----not available -----	-----not available -----	\$120.95	141.55	177.45	240.85
additional foil stamp run*	-----not available -----	-----not available -----	\$247.30	285.30	361.20	512.90
additional blind emboss run*	-----not available -----	-----not available -----	\$290.50	311.20	371.55	512.90

(R)

*Price includes 2 dies totaling up to 36 square inches.

Production time: 24 hours (ink or foil stamping),
3 working days (embossing), 5 working days (four color process)

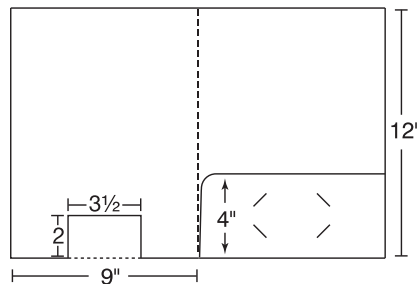

Item Number FLDR-BC1



Conformer® Folder
Item Number **FLDR-QL2**

Thicker materials like booklets and catalogs fit perfectly in our roomier Conformer® Folder Style QL-2. See **Additional Options for Pocket** pricing.

U.S. patent number is required to print on all Conformer® Products: 6,116,651
Conformer® Folder • 6,227,444 Conformer® Envelope. Conformer® is a registered trademark of CONFORMER PRODUCTS, INC.

legal folders

class 1 stocks	smart art code	50	100	250	500	1000	2000
no imprint 24hr	-	\$245.40	318.90	473.15	708.15	1104.70	1895.65
1 standard ink 24hr	1S	\$299.30	392.45	585.00	834.50	1260.00	2100.65
2 standard inks 24hr	1S	\$423.55	516.70	709.25	979.45	1439.15	2346.05
1 standard foil stamp* 24hr	1S	\$382.15	478.40	678.20	937.00	1380.10	2255.95
blind embossing*	1X	\$442.25	533.30	718.60	955.65	1390.45	2255.95
four color process	4C	-----not available -----		\$1384.25	1619.25	2015.80	2806.75

(R) Prices effective January, 2010

Please note: the above prices are for class 1 stocks. For all other stocks, please add the prices found on page 35. For more information on Smart Art Codes, visit www.smart-artwork.com. *Price includes 2 dies totaling up to 36 square inches.

additional options (add charges below to top prices)

	50	100	250	500	1000	2000
Conformer® Expansion Pocket (2 pockets)	\$31.30	38.55	57.70	80.05	121.35	187.65
heavy ink coverage	-----not available -----		\$175.35	187.45	211.60	259.95
uv coating	-----not available -----		\$175.35	187.45	211.60	259.95
each add'l standard ink color	-----not available -----		\$172.45	193.15	227.35	293.60
inside copy (above pockets)	-----not available -----		\$120.95	141.55	177.45	240.85
additional foil stamp run*	-----not available -----		\$247.30	285.30	361.20	512.90
additional blind emboss run*	-----not available -----		\$290.50	311.20	371.55	512.90

(R) Prices effective January, 2010

*Price includes 2 dies totaling up to 36 square inches.

Production time: 24 hours (ink or foil stamping),

3 working days (embossing), 8 working days (four color process)

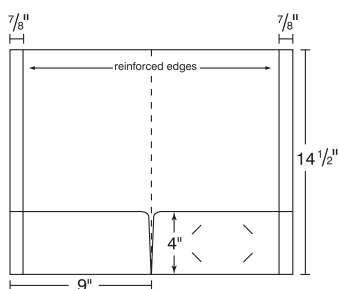

Item Number FLDR-L1 (1 pocket)
Item Number FLDR-L2 (2 pockets)

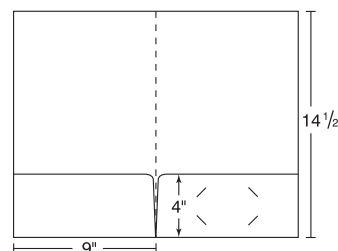

Item Number FLDR-M1 (1 pocket)
Item Number FLDR-M2 (2 pockets)

report covers

one or two piece

class 1 stocks	smart art code	50	100	250	500	1000	2000
no imprint 24hr	-	\$56.95	89.05	184.30	331.30	607.75	1023.95
1 standard ink 24hr	1S	\$110.85	162.60	296.15	457.65	763.05	1228.95
2 standard inks 24hr	1S	\$235.10	286.85	420.40	602.60	942.20	1474.35
1 standard foil stamp* 24hr	1S	\$193.70	248.55	389.35	560.15	883.15	1384.25
blind embossing*	1X	\$253.80	303.45	429.75	578.80	893.50	1384.25
four color process	4C	\$700.95	752.75	886.30	1068.45	1408.00	1940.20

(R) Prices effective January, 2010

Please note: the above prices are for class 1 stocks. For all other stocks, please add the prices found on page 35. For more information on Smart Art Codes, visit www.smart-artwork.com. *Price includes 2 dies totaling up to 36 square inches.

legal one or two piece

class 1 stocks	smart art code	50	100	250	500	1000	2000
no imprint 24hr	-	\$91.15	123.20	218.45	369.60	646.05	1014.60
1 standard ink 24hr	1S	\$145.05	196.75	330.30	495.95	801.35	1219.60
2 standard inks 24hr	1S	\$269.30	321.00	454.55	640.90	980.50	1465.00
1 standard foil stamp* 24hr	1S	\$227.90	282.70	423.50	598.45	921.45	1374.90
blind embossing*	1X	\$288.00	337.60	463.90	617.10	931.80	1374.90
four color process	4C	-----not available-----	-----	\$920.45	1106.80	1446.40	1930.90

(R) Prices effective January, 2010

Please note: the above prices are for class 1 stocks. For all other stocks, please add the prices found on page 35. For more information on Smart Art Codes, visit www.smart-artwork.com. *Price includes 2 dies totaling up to 36 square inches.

additional options (add charges below to top prices)

	50	100	250	500	1000	2000
NEW! variable data†	\$43.70	73.35	137.95	260.40	330.90	604.90
heavy ink coverage	-----not available-----	-----	\$175.35	187.45	211.60	259.95
uv coating	-----not available-----	-----	\$175.35	187.45	211.60	259.95
each add'l standard ink color	-----not available-----	-----	\$172.45	193.15	227.35	293.60
inside copy (above pockets)	-----not available-----	-----	\$120.95	141.55	177.45	240.85
additional foil stamp run*	-----not available-----	-----	\$247.30	285.30	361.20	512.90
additional blind emboss run*	-----not available-----	-----	\$290.50	311.20	371.55	512.90

(R) Prices effective January, 2010

*Price includes 2 dies totaling up to 36 square inches. †Available only on two piece report covers.

Production time: 24 hours (ink or foil stamping),

3 working days (embossing), 5 working days (four color process)

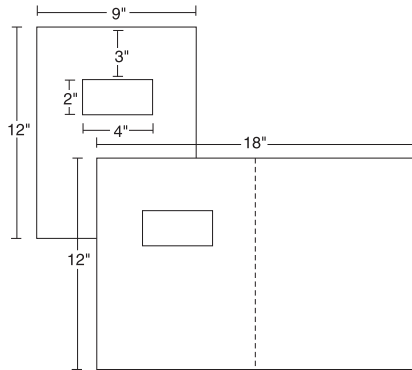

one piece
Item Number FLDR-R1
 (one piece report cover)
Item Number FLDR-W1
 (one piece report cover w/ window)

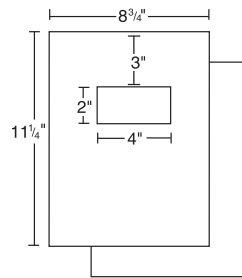

two piece
Item Number FLDR-R2
 (two piece report cover)
Item Number FLDR-W2
 (two piece report cover w/ window)

NEW!

Now available with Variable Data!

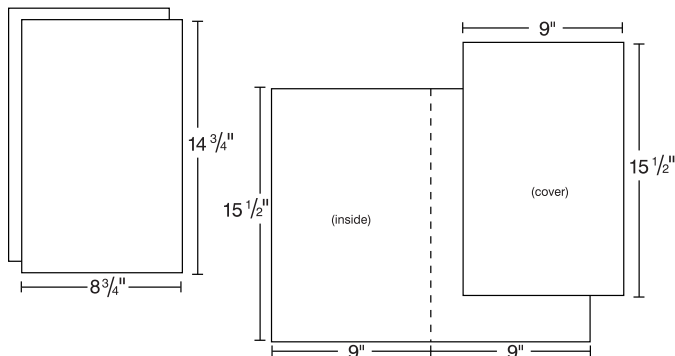

legal size

Item Number FLDR-R1L
 (one piece legal report cover)
Item Number FLDR-R2L
 (two piece legal report cover)

Item Number FLDR-W1L
 (one piece legal report cover w/ window)
Item Number FLDR-W2L
 (two piece legal report cover w/ window)

one piece

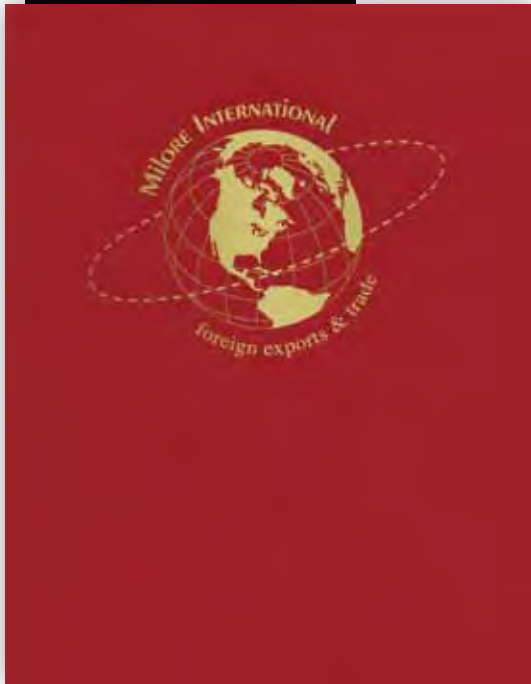

one piece
with window

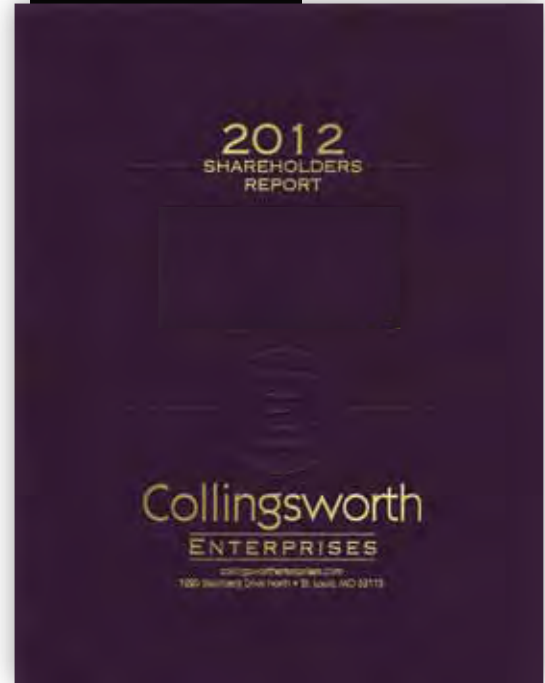

two piece

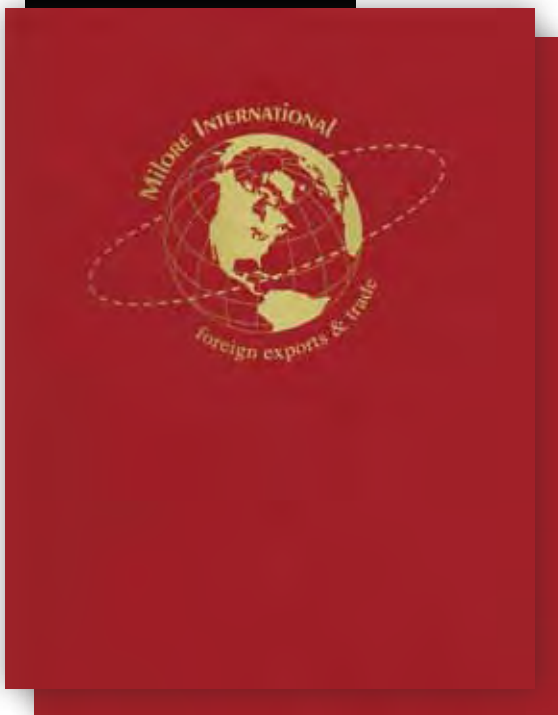

two piece
with window



small folders

literature folders

class 1 stocks	smart art code	50	100	250	500	1000	2000
no imprint 24hr	-	\$152.75	191.95	290.45	439.20	670.30	1070.30
1 standard ink 24hr	1S	\$205.10	263.30	399.00	561.80	821.05	1269.30
2 standard inks 24hr	1S	\$325.65	384.00	519.60	702.50	994.90	1507.50
1 standard foil stamp* 24hr	1S	\$285.50	346.75	489.45	661.30	937.65	1420.05
blind embossing*	1X	\$343.85	400.05	528.65	679.40	947.70	1420.05
four color process	4C	\$777.90	836.25	971.85	1154.75	1447.15	1959.75

(R) Prices effective January, 2010

Please note: the above prices are for class 1 stocks. For all other stocks, please add the prices found on page 35. For more information on Smart Art Codes, visit www.smart-artwork.com. *Price includes 2 dies totaling up to 36 square inches.

mini & document folders

class 1 stocks	smart art code	50	100	250	500	1000	2000
no imprint 24hr	-	\$163.85	208.05	319.60	487.40	773.85	1209.00
1 standard ink 24hr	1S	\$216.20	279.40	428.15	610.00	924.60	1408.00
2 standard inks 24hr	1S	\$336.70	400.05	548.80	750.75	1098.45	1646.15
1 standard foil stamp* 24hr	1S	\$296.60	362.85	518.60	709.50	1041.20	1558.75
blind embossing*	1X	\$354.95	416.15	557.80	727.60	1051.25	1558.75
four color process	4C	\$788.95	852.30	1001.05	1203.00	1550.70	2098.40

(R) Prices effective January, 2010

Please note: the above prices are for class 1 stocks. For all other stocks, please add the prices found on page 35. For more information on Smart Art Codes, visit www.smart-artwork.com. *Price includes 2 dies totaling up to 36 square inches.

additional options (add charges below to top prices)

	50	100	250	500	1000	2000
heavy ink coverage	-----not available -----		\$175.35	187.45	211.60	259.95
uv coating	-----not available -----		\$175.35	187.45	211.60	259.95
each add'l standard ink color	-----not available -----		\$172.45	193.15	227.35	293.60
inside copy (above pockets)	-----not available -----		\$120.95	141.55	177.45	240.85
additional foil stamp run*	-----not available -----		\$247.30	285.30	361.20	512.90
additional blind emboss run*	-----not available -----		\$290.50	311.20	371.55	512.90

(R) Prices effective January, 2010

*Price includes 2 dies totaling up to 36 square inches.

Production time: 24 hours (ink or foil stamping),

3 working days (embossing), 5 working days (four color process)

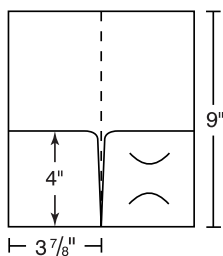

Item Number FLDR-E1 (1 pocket)
Item Number FLDR-E2 (2 pockets)

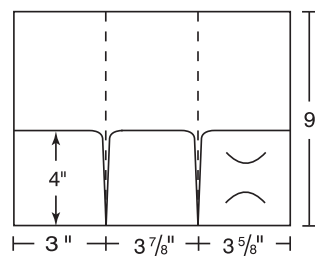

Item Number FLDR-E3 (3 pockets)
Reference page 6 for pricing.

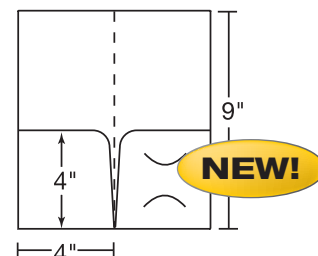

Item Number FLDR-ES1 (1 pocket)
Item Number FLDR-ES2 (2 pockets)

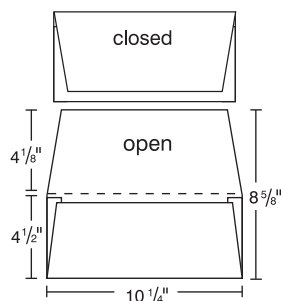

Item Number FLDR-K

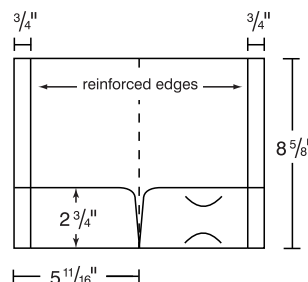

Item Number FLDR-I1 (1 pocket)
Item Number FLDR-I2 (2 pockets)

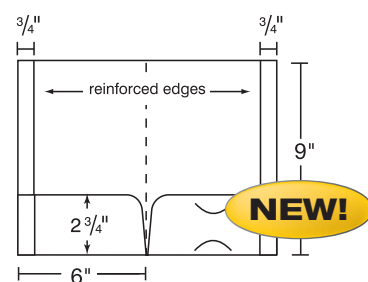

Item Number FLDR-IS1 (1 pocket)
Item Number FLDR-IS2 (2 pockets)

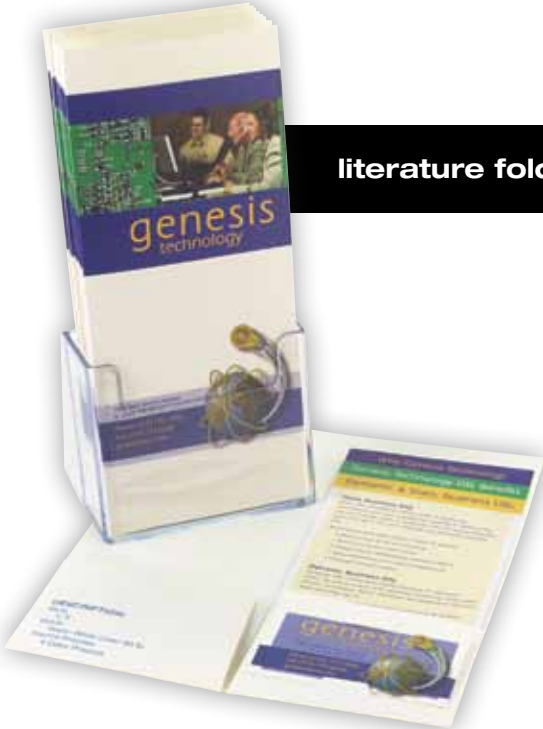

literature folders



mini folders



document folders

vertical pocket & landscape folders



vertical pocket & **NEW!** landscape folders

class 1 stocks	smart art code	250	500	1000	2000	2500	3000
no imprint 24hr	-	\$554.90	816.45	1325.00	2568.00	3028.25	3467.65
1 standard ink 24hr	1S	\$655.05	908.15	1403.00	2685.00	3137.90	3627.15
2 standard inks 24hr	1S	\$705.35	990.55	1457.50	2808.10	3296.60	3782.25
1 standard foil stamp* 24hr	1S	\$616.95	903.10	1421.60	2761.85	3221.55	3698.95
blind embossing*	1X	\$634.65	906.15	1439.40	2761.85	3221.55	3698.95
four color process	4C	\$1297.60	1570.55	2162.10	3662.15	4393.40	5115.60

(R) Prices effective January, 2010

Please note: the above prices are for class 1 stocks. For all other stocks, please add the prices found on page 35. For more information on Smart Art Codes, visit www.smart-artwork.com. *Price includes 2 dies totaling up to 36 square inches.

additional options (add charges below to top prices)

	250	500	1000	2000	2500	3000
heavy ink coverage	\$175.35	187.45	211.60	259.95	284.05	308.25
uv coating	\$175.35	187.45	211.60	259.95	284.05	308.25
each add'l standard ink color	\$172.45	193.15	227.35	293.60	324.65	350.55
inside copy (above pockets)	\$120.95	141.55	177.45	240.85	267.25	287.25
additional foil stamp run*	\$247.30	285.30	361.20	512.90	589.35	664.80
additional blind emboss run*	\$290.50	311.20	371.55	512.90	589.35	664.80

(R) Prices effective January, 2010

*Price includes 2 dies totaling up to 36 square inches.

Production time: 24 hours (ink or foil stamping),

3 working days (embossing), 5 working days (four color process)

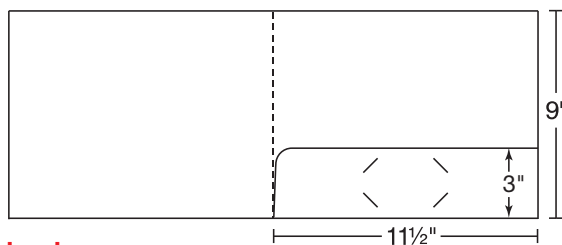

landscape
Item Number FLDR-LS1

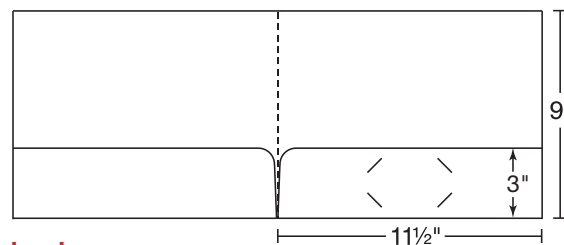

landscape
Item Number FLDR-LS2

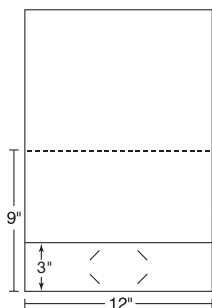

landscape
Item Number FLDR-LSB

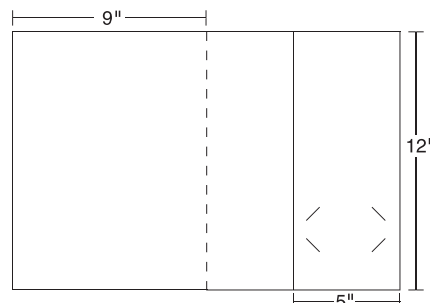

vertical pocket
Item Number FLDR-V1

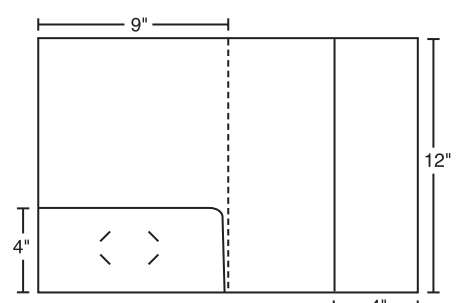

vertical pocket
Item Number FLDR-HV2



folders are great in the financial industry!
ideas include:

- welcome kit for new members
- 401k services
- commercial lending
- highlighting products and services
- trust documents



tri-fold folders

class 1 stocks	smart art code	250	500	1000	2000	2500	3000
no imprint 24hr	-	\$708.53	1071.17	1790.27	3203.25	3908.62	4603.53
1 standard ink 24hr	1S	\$856.90	1139.45	1926.25	3396.00	4128.00	4955.75
2 standard inks 24hr	1S	\$1028.30	1231.80	1965.55	3449.85	4187.00	5083.65
1 standard foil stamp* 24hr	1S	\$1101.75	1447.40	2162.10	3715.25	4422.90	5435.35
blind embossing*	1X	\$1150.70	1508.95	2240.75	3715.25	4422.90	5434.35
four color process	4C						

----- CALL FOR QUOTE -----

(R) Prices effective January, 2010

Please note: the above prices are for class 1 stocks. For all other stocks, please add the prices found on page 35. For more information on Smart Art Codes, visit www.smart-artwork.com. *Price includes 2 dies totaling up to 36 square inches.

additional options (add charges below to top prices)

	250	500	1000	2000	2500	3000
heavy ink coverage	\$175.35	187.45	211.60	259.95	284.05	308.25
uv coating	\$175.35	187.45	211.60	259.95	284.05	308.25
each add'l standard ink color	\$172.45	193.15	227.35	293.60	324.65	350.55
inside copy (above pockets)	\$120.95	141.55	177.45	240.85	267.25	287.25
additional foil stamp run*	\$247.30	285.30	361.20	512.90	589.35	664.80
additional blind emboss run*	\$290.50	311.20	371.55	512.90	589.35	664.80

(R) Prices effective January, 2010

*Price includes 2 dies totaling up to 36 square inches.

Production time: 24 hours (ink or foil stamping),
 3 working days (embossing), 8 working days (four color process)

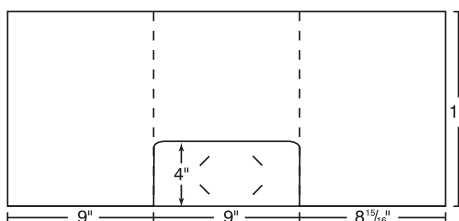

Item Number FLDR-FM1
 (glued middle pocket)

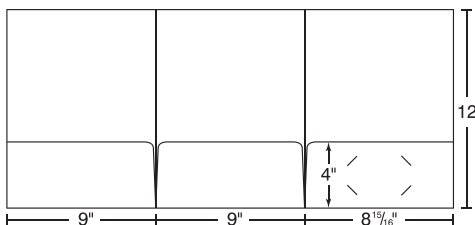

Item Number FLDR-F3
 (glued outside pockets, unglued middle pocket)

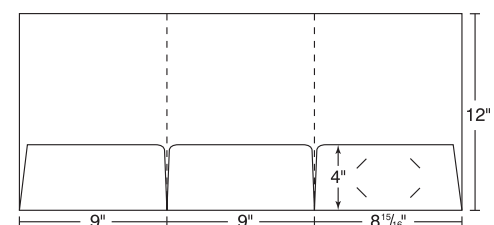

Item Number FLDR-A3
 (all pockets unglued)

For quantities not shown, please call for quote.

loose pocket folders



**endless opportunities
in the legal market!
ideas include:**

- client portfolios
- policies & procedures
- estate documents
- courtroom litigations
- contracts



loose pocket folders

class 1 stocks	smart art code	50	100	250	500	1000	2000
no imprint 24hr	-	\$155.30	205.05	341.05	497.35	789.70	1325.60
1 standard ink 24hr	1S	\$208.10	277.15	450.70	621.20	941.95	1526.60
2 standard inks 24hr	1S	\$329.90	398.95	572.50	763.30	1117.55	1767.15
1 standard foil stamp* 24hr	1S	\$289.30	361.40	542.05	721.70	1059.70	1678.85
blind embossing*	1X	\$348.25	415.20	581.65	740.00	1069.85	1678.85
four color process	4C	\$786.65	855.70	1029.25	1220.05	1574.30	2223.90

(R) Prices effective January, 2010

Please note: the above prices are for class 1 stocks. For all other stocks, please add the prices found on page 35. For more information on Smart Art Codes, visit www.smart-artwork.com. *Price includes 2 dies totaling up to 36 square inches.

additional options (add charges below to top prices)

	50	100	250	500	1000	2000
heavy ink coverage	-----not available -----		\$175.35	187.45	211.60	259.95
uv coating	-----not available -----		\$175.35	187.45	211.60	259.95
each add'l standard ink color	-----not available -----		\$172.45	193.15	227.35	293.60
inside copy (above pockets)	-----not available -----		\$120.95	141.55	177.45	240.85
additional foil stamp run*	-----not available -----		\$247.30	285.30	361.20	512.90
additional blind emboss run*	-----not available -----		\$290.50	311.20	371.55	512.90

(R) Prices effective January, 2010

*Price includes 2 dies totaling up to 36 square inches.

Production time: 24 hours (ink or foil stamping),
3 working days (embossing), 5 working days (four color process)

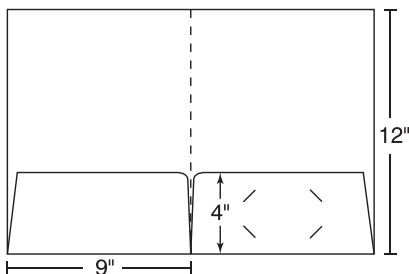

Item Number **FLDR-A1** (1 unglued pocket)
Item Number **FLDR-A2** (2 unglued pockets)

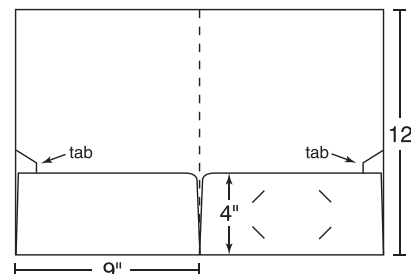

Item Number **FLDR-A1S** (1 unglued pocket, self-assemble tab)
Item Number **FLDR-A2S** (2 unglued pockets, self-assemble tabs)

multicolor features

- 9" x 12" Secured Pocket Folder
- available in flat ink only
- price includes:
 - one photo or logo scan
 - up to 20 lines of type
- stock: smooth white cover 80 lb.
- heavy ink coverage not available

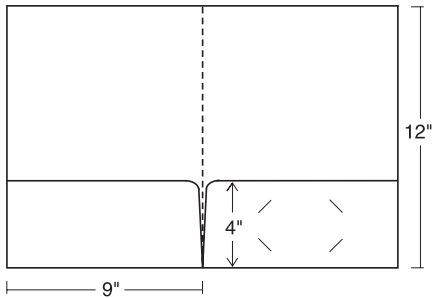

Item Number FLDR-MC2



multicolor inks

N0001	N0002	N0003	N0004	N0005	N0006	N0007	N0008	N0009	N00010	N0011	N0012	N0013
N0014	N0015	N0016	N0017	N0018	N0019	N0020	N0021	N0022	N0023	N0024	N0025	N0026
N0027	N0028	N0029	N0030	N0031	N0032	N0033	N0034	N0035	N0036	N0037	N0038	N0039
N0040	N0041	N0042	N0043	N0044	N0045	N0046	N0047	N0048	N0050	N0051	N0053	N0054
N0055	N0056	N0057	N0058	N0059	N0060	N0061	N0062	N0063	N0098	N0099	Note: All ink colors will be printed with flat ink.	

	smart art code	50	100	150	200	250	500	1000	2000
1 color	4C	\$259.85	355.90	430.90	500.60	565.00	845.90	1346.45	2962.85
2 color	4C	\$274.60	374.90	459.40	539.65	614.65	948.35	1539.70	3256.05
3 color	4C	\$289.40	393.95	487.90	578.75	664.25	1050.75	1732.95	3549.30
4 color	4C	\$304.20	412.95	516.45	617.80	713.90	1153.20	1926.20	3842.50
5 color	4C	\$318.95	431.95	544.95	656.85	763.55	1255.65	2119.45	4135.70
6 color	4C	\$333.75	450.95	573.45	695.95	813.15	1358.05	2312.65	4428.95
7 color	4C	\$348.50	469.95	601.95	735.05	862.80	1460.50	2505.95	4721.95

(R) Prices effective January, 2010

For more information on Smart Art Codes, visit www.smart-artwork.com.

Production time: 5 working days

For quantities not shown, please call for quote.

certificate holders

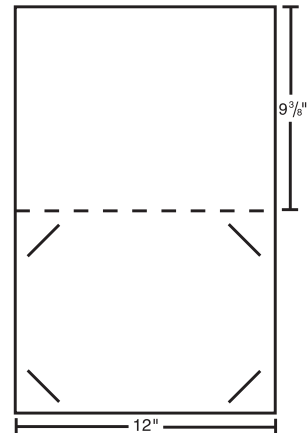

Item Number FLDR-CH
Fits an 8½" x 11" certificate

decorative borders are available at no extra charge

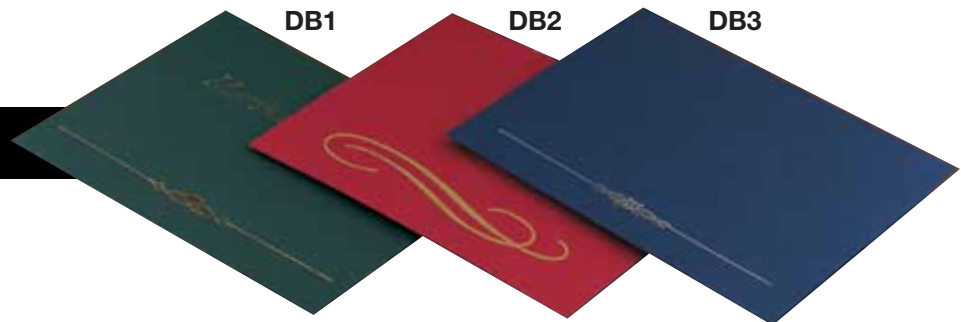

certificate holders

class 1 stocks	smart art code	50	100	250	500	1000	2000
no imprint 24hr	-	\$56.95	89.05	184.30	324.80	595.80	1003.85
1 standard ink 24hr	1S	\$110.85	162.60	296.20	448.65	748.05	1204.85
2 standard inks 24hr	1S	\$235.10	286.85	420.45	590.75	923.65	1445.40
1 standard foil stamp* 24hr	1S	\$193.65	248.55	389.35	549.15	865.80	1357.10
blind embossing*	1X	\$253.75	303.40	429.75	567.45	875.95	1357.10
four color process	4C	\$700.95	752.70	886.30	1047.50	1380.40	1902.15

(R) Prices effective January, 2010

Please note: the above prices are for class 1 stocks. For all other stocks, please add the prices found on page 35. For more information on Smart Art Codes, visit www.smart-artwork.com. *Price includes 2 dies totaling up to 36 square inches.

additional options (add charges below to top prices)

	50	100	250	500	1000	2000
NEW! variable data	\$43.70	73.35	137.95	260.40	330.90	604.90
heavy ink coverage	-----not available	-----	\$175.35	187.45	211.60	259.95
uv coating	-----not available	-----	\$175.35	187.45	211.60	259.95
each add'l standard ink color	-----not available	-----	\$172.45	193.15	227.35	293.60
inside copy (above pockets)	-----not available	-----	\$120.95	141.55	177.45	240.85
additional foil stamp run*	-----not available	-----	\$247.30	285.30	361.20	512.90
additional blind emboss run*	-----not available	-----	\$290.50	311.20	371.55	512.90

(R) Prices effective January, 2010

*Price includes 2 dies totaling up to 36 square inches.

Production time: 24 hours (ink or foil stamping),
3 working days (embossing), 5 working days (four color process)



NEW! variable data

Variable data products have changing elements within each product. Examples include: a name or address, phone number or title, a price, an image or a background.

requirements

Variable data folders are easy to order. Just provide the following:

- A composite proof of what the finished folders will look like
- All art or images that will be a part of the folder
- A database file

4" x 6" photo holders

class 1 stocks	smart art code	50	100	250	500	1000	2000
1 standard ink 24hr	1S	\$329.60	388.80	552.05	834.25	1385.95	2589.05
2 standard inks 24hr	1S	\$393.95	454.15	641.60	956.70	1550.90	2695.15
1 standard foil stamp* 24hr	1S	\$332.10	391.60	576.25	870.90	1445.85	2722.75
blind embossing*	1X	\$335.00	397.35	590.75	899.90	1503.35	2837.75
four color process	4C	\$507.75	569.25	821.95	1123.35	1618.70	2817.55

(R) Prices effective January, 2010

Please note: the above prices are for class 1 stocks. For all other stocks, please add the prices found on page 35. For more information on Smart Art Codes, visit www.smart-artwork.com. *Price includes 2 dies totaling up to 36 square inches.

5" x 7" photo holders

class 1 stocks	smart art code	50	100	250	500	1000	2000
1 standard ink 24hr	1S	\$335.20	395.95	577.55	874.30	1469.65	2747.55
2 standard inks 24hr	1S	\$399.55	461.30	660.40	996.75	1634.60	2853.65
1 standard foil stamp* 24hr	1S	\$337.70	398.75	595.05	910.95	1529.55	2881.25
blind embossing*	1X	\$340.60	404.50	609.55	939.95	1587.05	2996.25
four color process	4C	\$513.35	576.40	840.75	1163.40	1702.40	2976.05

(R) Prices effective January, 2010

Please note: the above prices are for class 1 stocks. For all other stocks, please add the prices found on page 35. For more information on Smart Art Codes, visit www.smart-artwork.com. *Price includes 2 dies totaling up to 36 square inches.

additional options (add charges below to top prices)

	50	100	250	500	1000	2000
NEW! variable data	\$43.70	73.35	137.95	260.40	330.90	604.90
heavy ink coverage	-----not available -----		\$175.35	187.45	211.60	259.95
uv coating	-----not available -----		\$175.35	187.45	211.60	259.95
each add'l standard ink color	-----not available -----		\$172.45	193.15	227.35	293.60
inside copy (above pockets)	-----not available -----		\$120.95	141.55	177.45	240.85
additional foil stamp run*	-----not available -----		\$247.30	285.30	361.20	512.90
additional blind emboss run*	-----not available -----		\$290.50	311.20	371.55	512.90

(R) Prices effective January, 2010

*Price includes 2 dies totaling up to 36 square inches.

Production time: 24 hours (ink or foil stamping), 3 working days (embossing), 5 working days (four color process)

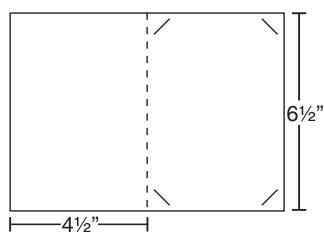

Item Number FLDR-PHA
Fits 4" x 6" photo

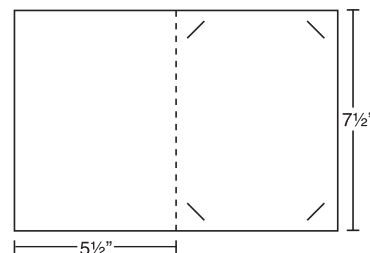

Item Number FLDR-PHB
Fits 5" x 7" photo

card carriers



card carriers

class 1 stocks	smart art code	250	500	1000	2000	2500	3000
no imprint 24hr	-	\$153.00	187.50	256.50	394.50	463.50	532.50
1 standard ink 24hr	1S	\$271.50	309.00	384.00	534.00	609.00	682.50
2 standard inks 24hr	1S	\$369.90	423.85	525.90	728.40	828.00	922.00
1 standard foil stamp* 24hr	1S	\$427.40	477.60	576.90	764.30	853.00	941.00
blind embossing*	1X	\$467.00	495.90	587.05	764.30	853.00	941.00
four color process	4C	\$614.10	679.00	785.00	996.00	1101.00	1205.50

(R) Prices effective January, 2010

Please note: the above prices are for class 1 stocks. For all other stocks, please add the prices found on page 35. For more information on Smart Art Codes, visit www.smart-artwork.com. *Price includes 2 dies totaling up to 36 square inches.

additional options (add charges below to top prices)

	250	500	1000	2000	2500	3000
heavy ink coverage	\$175.35	187.45	211.60	259.95	284.05	308.25
uv coating	\$175.35	187.45	211.60	259.95	284.05	308.25
each add'l standard ink color	\$172.45	193.15	227.35	293.60	324.65	350.55
inside copy (above pockets)	\$120.95	141.55	177.45	240.85	267.25	287.25
additional foil stamp run*	\$247.30	285.30	361.20	512.90	589.35	664.80
additional blind emboss run*	\$290.50	311.20	371.55	512.90	589.35	664.80

(R) Prices effective January, 2010

*Price includes 2 dies totaling up to 36 square inches.

Production time: 24 hours (ink or foil stamping), 3 working days (embossing), 5 working days (four color process)

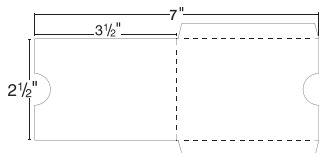

Item Number FLDR-CJ
22

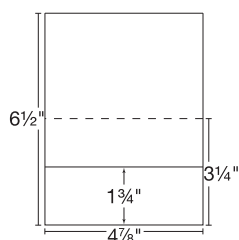

Item Number FLDR-CF

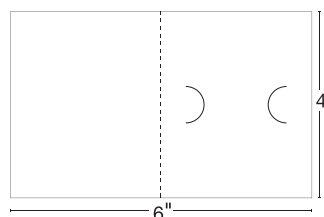

Item Number FLDR-CU

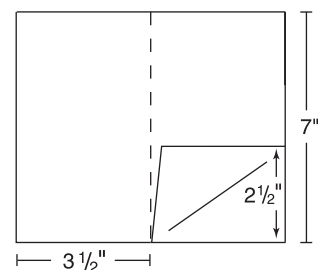

Item Number FLDR-Y

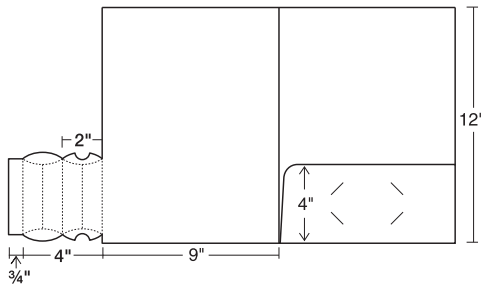

Item Number FLDR-FDF

flash drive folder



class 1 stocks	smart art code	250	500	1000	2000	2500	3000
no imprint 24hr	-	\$554.90	816.45	1325.00	2568.00	3028.25	3467.65
1 standard ink 24hr	1S	\$655.05	908.15	1403.00	2685.00	3137.90	3627.15
2 standard inks 24hr	1S	\$705.35	990.55	1457.50	2808.10	3296.60	3782.25
1 standard foil stamp* 24hr	1S	\$616.95	903.10	1421.60	2761.85	3221.55	3698.95
blind embossing*	1X	\$634.65	906.15	1439.40	2761.85	3221.55	3698.95
four color process	4C	\$1297.60	1570.55	2162.10	3662.15	4393.40	5115.60

(R) Prices effective January, 2010

Please note: the above prices are for class 1 stocks. For all other stocks, please add the prices found on page 35.

For more information on Smart Art Codes, visit www.smart-artwork.com. *Price includes 2 dies totaling up to 36 square inches.

Production time: 24 hours (ink or foil stamping),
3 working days (embossing)
5 working days (four color process)

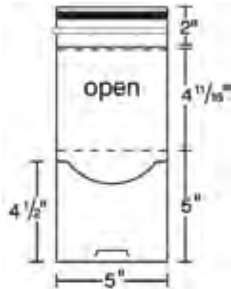

Item Number FLDR-ZZ

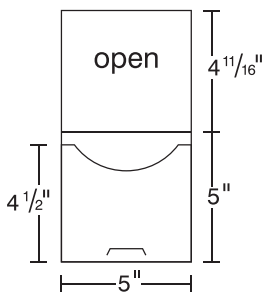

Item Number FLDR-Z

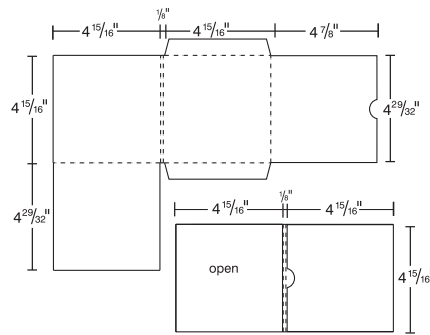

Item Number FLDR-ZF

multimedia holders & flash drive holders

class 1 stocks	smart art code	50	100	250	500	1000	2000
no imprint 24hr	-	\$157.40	197.75	303.35	449.35	686.40	1047.75
1 standard ink 24hr	1S	\$211.30	271.30	415.20	575.70	841.70	1252.75
2 standard inks 24hr	1S	\$335.55	395.55	539.45	720.65	1020.85	1498.15
1 standard foil stamp* 24hr	1S	\$294.15	357.25	508.40	678.20	961.80	1408.05
blind embossing*	1X	\$354.25	412.15	548.80	696.85	972.15	1408.05
four color process	4C	\$801.45	861.45	1005.35	1186.55	1486.75	1964.05

(R) Prices effective January, 2010

Please note: the above prices are for class 1 stocks. For all other stocks, please add the prices found on page 35. Multimedia holders are printed with flat ink ONLY.

For more information on Smart Art Codes, visit www.smart-artwork.com. *Price includes 2 dies totaling up to 36 square inches.

Production time: 24 hours (ink or foil stamping),
3 working days (embossing)
5 working days (four color process)

For quantities not shown, please call for quote.

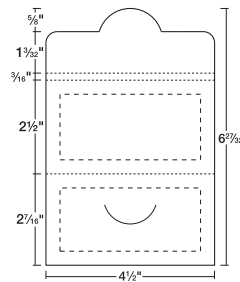

Item Number FLDR-FDH

paper portfolios



expandable & non-expandable paper portfolios

class 1 stocks	smart art code	250	500	100	2000	2500	3000
no imprint 24hr	-	\$554.90	816.45	1325.00	2568.00	3028.25	3467.65
1 standard ink 24hr	1S	\$655.05	908.15	1403.00	2685.00	3137.90	3627.15
2 standard inks 24hr	1S	\$705.35	990.55	1457.50	2808.10	3296.60	3782.25
1 standard foil stamp* 24hr	1S	\$616.95	903.10	1421.60	2761.85	3221.55	3698.95
blind embossing*	1X	\$634.65	906.15	1439.40	2761.85	3221.55	3698.95
four color process	4C	\$1297.60	1570.55	2162.10	3662.15	4393.40	5115.60

(R) Prices effective January, 2010

Please note: the above prices are for class 1 stocks. For all other stocks, please add the prices found on page 35.

For more information on Smart Art Codes, visit www.smart-artwork.com. *Price includes 2 dies totaling up to 36 square inches.

Production time: 24 hours (ink or foil stamping),

3 working days (embossing)

5 working days (four color process)

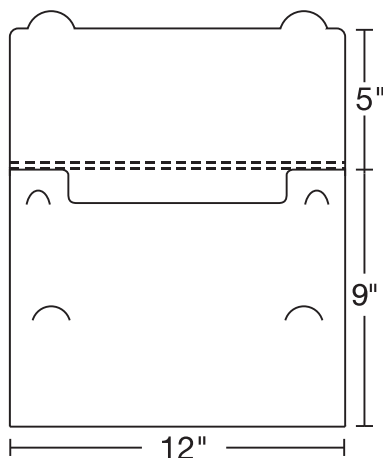

expandable - 1/4" expansion
Item Number PORT-PE

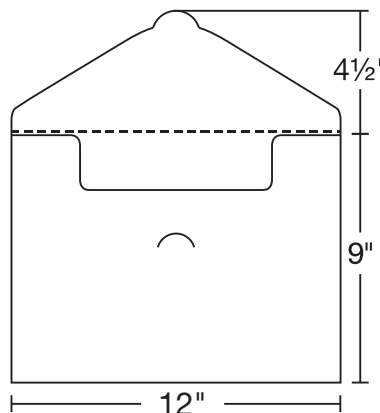

non-expandable
Item Number PORT-PNE

poly folders & portfolios

poly features

- available as a 9" x 12" Folder or 9½" x 12½" Poly Portfolio
- poly colors: black, par blue, white, red, clear matte
- standard screen ink colors: black, reflex blue, red
- special screen ink & poly colors are available. Call for quote.
- image size up to 36 square inches



poly folders (price per piece)

	smart art code	250	500	1000	2500
blank		\$3.42	2.44	1.88	1.60
1 standard screen color	1S	\$5.01	3.46	2.50	2.03
2 standard screen colors	1S	\$6.59	4.47	3.13	2.46

poly portfolios (price per piece)

	smart art code	250	500	1000	2500
blank		\$2.95	2.19	1.71	1.50
1 standard screen color	1S	\$4.54	3.21	2.33	1.94
2 standard screen colors	1S	\$6.13	4.22	2.96	2.37

(T) Prices effective January, 2010

For more information on Smart Art Codes, visit www.smart-artwork.com.

Production time: 4 weeks

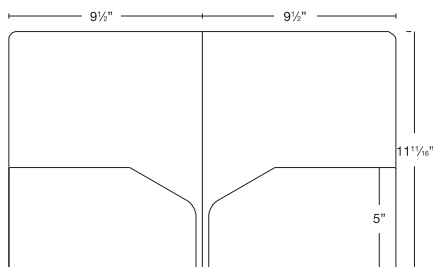

Item Number FLDR-POLY

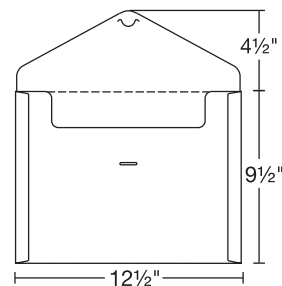

Item Number PORT-POLY

For quantities not shown, please call for quote.

conformer® envelopes & portfolios

conformer® tip

Place a FedEx®, Priority Mail® or UPS® shipping label directly onto your Conformer® Envelope, promoting your corporate identity instead of your courier's.



U.S. patent number is required to print on all Conformer® Products: 6,116,651 Conformer® Folder • 6,227,444 Conformer® Envelope. Conformer® is a registered trademark of CONFORMER PRODUCTS, INC.

versatility at its finest

The Conformer® is just the right option when you have more than your regular Folder can hold!

This unique solution can accommodate contents of various thicknesses while offering the protection of a rigid paperboard, thus making it the most versatile in its class.

Conformer® standard envelopes & portfolios

class 1 stocks	smart art code	50	100	250	500	1000	2000
1 standard ink 24hr	1S	\$559.15	634.70	820.00	1076.80	1568.50	2542.75
2 standard inks 24hr	1S	\$683.40	758.95	944.25	1221.75	1747.65	2788.15
1 standard foil stamp* 24hr	1S	\$642.00	720.65	913.20	1179.30	1688.60	2698.05
blind embossing*	1X	\$702.10	775.55	953.60	1197.95	1698.95	2698.05
four color process	4C	\$1519.85	1586.10	1743.45	1997.15	2504.45	3519.05

(R) Prices effective January, 2010

Please note: the above prices are for class 1 stocks. For all other stocks, please add the prices found on page 35. For more information on Smart Art Codes, visit www.smart-artwork.com. *Price includes 2 dies totaling up to 36 square inches.

Conformer® legal envelopes & portfolios

class 1 stocks	smart art code	50	100	250	500	1000	2000
1 standard ink 24hr	1S	\$576.35	669.15	905.95	1210.35	1801.45	2979.60
2 standard inks 24hr	1S	\$700.60	793.40	1030.20	1355.30	1980.60	3225.00
1 standard foil stamp* 24hr	1S	\$659.20	755.10	999.15	1312.85	1921.55	3134.90
blind embossing*	1X	\$719.30	810.00	1039.55	1331.50	1931.90	3134.90
four color process	4C	-----not available -----		\$1779.95	2065.55	2619.40	3733.20

(R) Prices effective January, 2010

Please note: the above prices are for class 1 stocks. For all other stocks, please add the prices found on page 35. For more information on Smart Art Codes, visit www.smart-artwork.com. *Price includes 2 dies totaling up to 36 square inches.

additional options (add charges below to top prices)

	50	100	250	500	1000	2000
tape	\$81.65	81.65	81.65	111.00	169.65	287.00
heavy ink coverage	-----not available -----		\$175.35	187.45	211.60	259.95
uv coating	-----not available -----		\$175.35	187.45	211.60	259.95
each add'l standard ink color	-----not available -----		\$172.45	193.15	227.35	293.60
additional foil stamp run*	-----not available -----		\$247.30	285.30	361.20	512.90
additional blind emboss run*	-----not available -----		\$290.50	311.20	371.55	512.90

(R) Prices effective January, 2010

*Price includes 2 dies totaling up to 36 square inches.

Production time: 24 hours (ink or foil stamping), 3 working days (embossing), 5 working days (four color process)

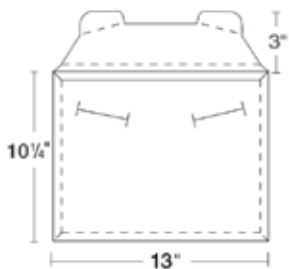

Conformer® Portfolio
Item Number PORT-QET

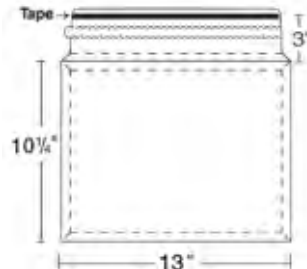

Conformer® Envelope
Item Number ENV-QEZ

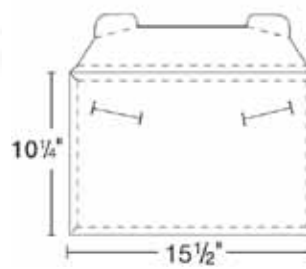

Legal Conformer® Portfolio
Item Number PORT-QETL

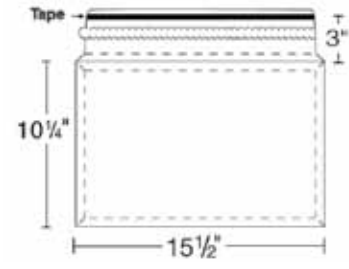

Legal Conformer® Envelope
Item Number ENV-QEZL

binders & index tabs

binder features

- standard binders accommodate 11" x 8½" documents with a ½" tab allowance. custom binders are available upon request.
- vinyl: French Calf and Suedene
- vinyl colors: warm white, bright white, black, royal blue, red, green, azure blue, gray
- chrome, spine-mounted round rings with boosters are standard.
- rivets are exposed.
- a liner to match your cover material is added for a professional look.
- one or two pockets available for additional charge. Call for quote.



case dimensions

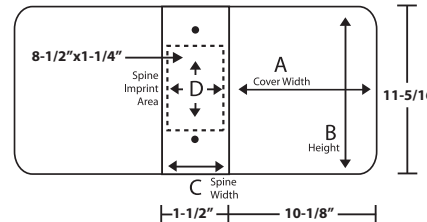

imprint positions

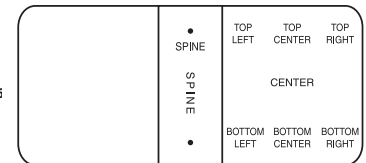

vinyl binders (price per piece)

Item Number: VINYL BINDER	capacity	50	100	250	500	1000
no imprint	1" ring	\$6.50	4.95	4.70	4.55	4.40
	1½" ring	\$6.90	5.45	4.95	4.75	4.60
	2" ring	\$7.75	6.45	5.95	5.65	5.55
1 standard silkscreen color	1" ring	\$9.80	6.75	5.60	5.05	4.75
	1½" ring	\$10.20	7.25	5.85	5.30	4.95
	2" ring	\$11.00	8.25	6.85	6.20	5.90
2 standard silkscreen colors	1" ring	\$13.05	8.60	6.45	5.60	5.10
	1½" ring	\$13.45	9.10	6.70	5.80	5.30
	2" ring	\$14.30	10.10	7.70	6.70	6.25
1 standard foil	1" ring	\$9.20	6.35	5.70	5.25	4.95
	1½" ring	\$9.60	6.85	5.95	5.45	5.15
	2" ring	\$10.45	7.85	6.95	6.35	6.10

(R) Prices effective January, 2010

Production time: 10 working days

index tab features

- sheet size: 11" x 8½"
- stock: 90 lb., white index stock with square corners
- tab copy typesetting included in your choice of typestyle. if typestyle is not indicated, Swiss Bold Caps will be used.
- choice of 6 tab copy positions
- maximum of 2 lines of copy per tab, printed on two sides in black ink.
- tabs extend ½" from sheet side
- sheets come with three ¼" diameter round holes and a ⅝" reinforced binding edge.
- tabs are packaged uncollated
- reinforced holes with tear-protection edge

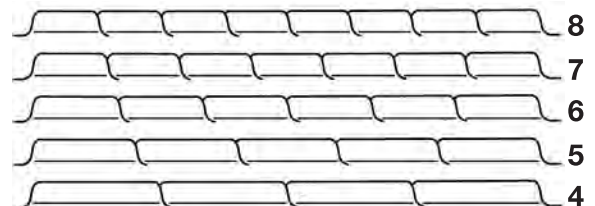
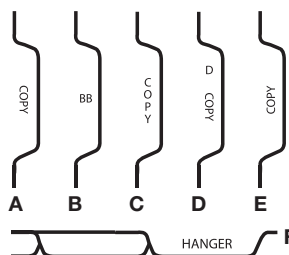
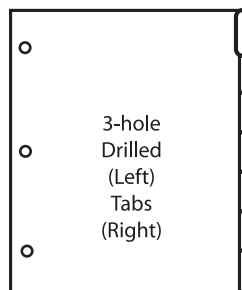

index tabs (price per set)

	tabs/set	50	100	250	500	1000
black ink	4	\$3.75	2.05	1.45	1.05	.80
black ink	5	\$4.10	2.35	1.65	1.25	1.00
black ink	6	\$4.70	2.65	1.80	1.35	1.20
black ink	7	\$4.95	2.95	2.00	1.60	1.40
black ink	8	\$5.20	3.25	2.15	1.65	1.45

(R) Prices effective January, 2010

Production time: 7 working days

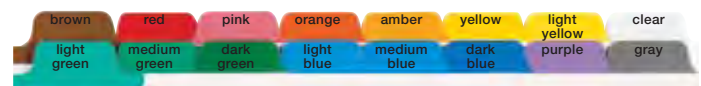

additional options

ink colors (other than black) \$94.65 (R)

(R) Prices effective January, 2010

stepped & stitched inserts

stepped inserts

style FL1	smart art code	# of sheets	100	250	500	1000	1500	2000
ITEM NUMBER: INSERT-FL15								
2 standard inks	1S	5	\$600.50	723.70	865.55	1138.85	1399.75	1663.75
four color process	4C	5	\$1184.40	1221.65	1384.20	1690.65	1966.05	2262.15
ITEM NUMBER: INSERT-FL16								
2 standard inks	1S	6	\$621.20	748.55	906.95	1212.35	1501.20	1795.25
four color process	4C	6	\$1214.45	1252.75	1432.90	1770.40	2076.85	2404.00
ITEM NUMBER: INSERT-FL17								
2 standard inks	1S	7	\$648.10	781.65	972.15	1338.65	1712.40	2048.90
four color process	4C	7	\$1258.95	1322.10	1467.05	1868.75	2236.25	2627.60
ITEM NUMBER: INSERT-FL18								
2 standard inks	1S	8	\$667.80	805.50	1012.55	1410.10	1792.10	2177.25
four color process	4C	8	\$1412.15	1456.70	1685.50	2107.90	2513.75	2925.80
style FL2								
ITEM NUMBER: INSERT-FL25								
2 standard inks	1S	5	\$414.15	520.80	603.60	799.25	985.65	1172.00
four color process	4C	5	\$855.20	882.10	998.05	1215.45	1410.10	1619.25
ITEM NUMBER: INSERT-FL26								
2 standard inks	1S	6	\$451.40	564.25	634.65	852.05	1060.15	1268.25
four color process	4C	6	\$880.05	908.00	1036.35	1274.45	1490.85	1720.70
ITEM NUMBER: INSERT-FL27								
2 standard inks	1S	7	\$466.95	563.20	689.55	946.30	1191.65	1440.10
four color process	4C	7	\$1038.45	1071.55	1220.65	1498.10	1753.80	2025.05
ITEM NUMBER: INSERT-FL28								
2 standard inks	1S	8	\$483.50	582.90	719.55	999.10	1263.10	1531.25
four color process	4C	8	\$1065.35	1098.45	1258.95	1560.20	1836.65	2126.55
style FL3								
ITEM NUMBER: INSERT-FL35								
2 standard inks	1S	5	\$414.15	500.05	602.55	760.95	910.05	1059.15
four color process	4C	5	\$803.40	829.30	922.45	1090.20	1250.65	1414.25
ITEM NUMBER: INSERT-FL36								
2 standard inks	1S	6	\$430.70	519.75	633.60	812.75	984.60	1152.30
four color process	4C	6	\$820.00	845.85	950.45	1137.80	1319.00	1501.20
ITEM NUMBER: INSERT-FL37								
2 standard inks	1S	7	\$459.70	554.95	682.30	908.00	1122.30	1338.65
four color process	4C	7	\$840.70	867.60	1000.10	1245.50	1468.10	1704.10
ITEM NUMBER: INSERT-FL38								
2 standard inks	1S	8	\$475.20	573.60	713.35	960.80	1196.85	1433.90
four color process	4C	8	\$1035.30	1067.40	1212.35	1472.20	1719.65	1972.25

(R) Prices effective January, 2010

Price includes one-sided printing. For second side printing, please call for quote.

Production time: add 6 working days to folder production

stitched inserts

item number	# of sheets	# of pages	1000	2000	2500
INSERT-STITCH1	1	4	\$1397.70	1898.10	1982.70
INSERT-STITCH2	2	8	\$1946.45	2415.75	2843.70
INSERT-STITCH3	3	12	\$2678.00	3451.00	4004.95
INSERT-STITCH4	4	16	\$3392.35	4831.45	5167.95

(R) Prices effective January, 2010

Price includes two-sided printing and stitching. For more information on Smart Art Codes, visit www.smart-artwork.com.

Production time: add 5 working days to folder production

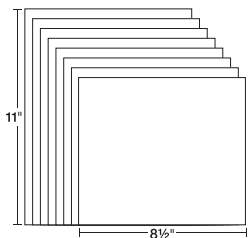

Style INSERT-FL1
Fits 9" x 12" Folder

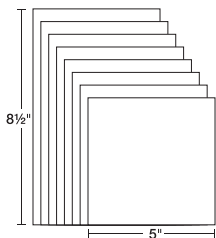

Style INSERT-FL2
Fits Mini Folder

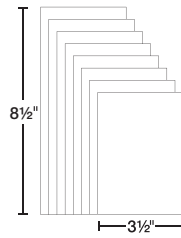

Style INSERT-FL3
Fits Literature Folder

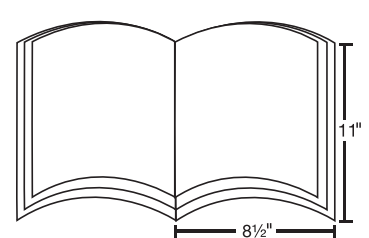

Style INSERT-ISC

stepped & stitched inserts

stepped insert features

- horizontal stepped inserts shown. Vertical stepped inserts available. Please call for quote.
- stock: gloss coated text in 80 lb. or 100 lb., or matte text white 80 lb.
- size: 8½" x 11", 5" x 8½" or 3½" x 8½". Insert sheets have a ½" difference in height. Additional sheet sizes available; please call for quote.
- collate: price includes collating and insertion
- all inserts will be placed in the right pocket unless otherwise specified.

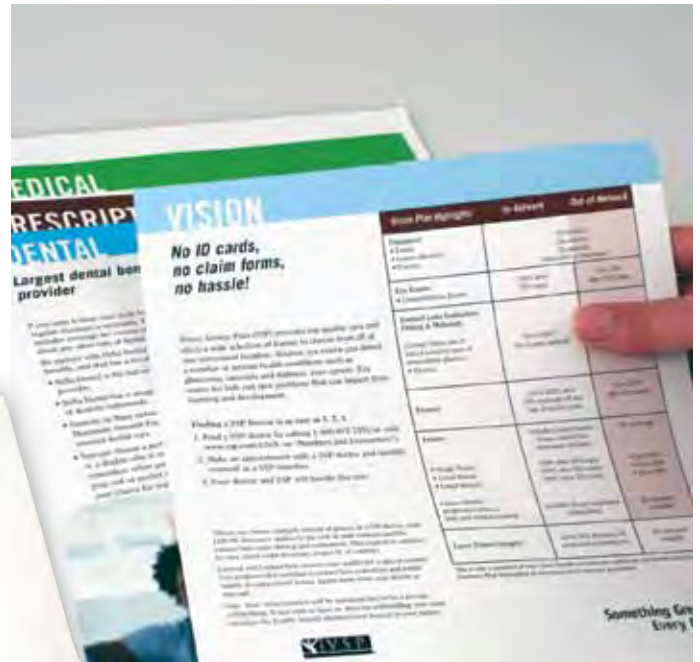

stitched insert features

- stock: gloss coated white 80 lb. text
- imprint: four color, both sides
- size: 11" x 17" open; 8½" x 11" closed. Additional sheet sizes available, please call for quote.



custom cube holders



personalized cubes are great for each employee; one holder design perfect for the entire company!

custom cube holder features

- keep your message at their fingertips
- durable 18 pt. cover stock
- great money-saving alternative to acrylic holders
- fits a 2 $\frac{3}{4}$ " x 2 $\frac{3}{4}$ " Post-it® Note Cube
- reusable with re-orders on Post-it® Note Cubes
- available in four color process or in standard imprint colors: black, red, green, reflex blue, gray, dark blue, light blue, burgundy, brown or teal (flat ink only; outside printing only).
- holders are shipped flat & unassembled. Post-it® Note Cubes sold separately. For pricing on inserting cubes inside holder, shrink wrapping or assembling holders; call for quote

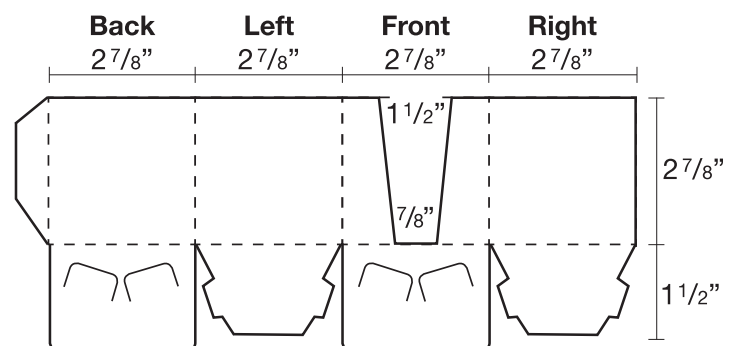

Item Number FLDR-PIN

custom cube holders (price per lot)

description	100 holders	200 holders	500 holders	1000 holders
1 standard ink color	\$275.00	323.50	599.50	892.10
2 standard ink colors	\$397.10	511.50	741.40	1059.30
4 color process	\$1190.20	1228.70	1335.40	1470.70

(R) Prices effective January, 2010

Production time: 2 working days for 1 & 2 colors; 5 working days for 4 color process

promotional packaging



promotional packaging features:

- stock: low luster white 15 or 18 pt.
- one or two flat ink colors or 4 color process
- bleeds available at no extra charge
- includes slits for business card placement

financial design

imprint area:
large box - 9¼" x 3⅞"
small box - 5½" x 2¼"



swirl design

imprint area:
large box - 6⅞" x 2"
small box - 3¾" x 1⅞"



tech design

imprint area:
large box - 8⅞" x 3¾"
small box - 5" x 2"



templated designs are priced as four color process.

promotional packaging - small box (price per box)

	smart art code	250	500	1000	2000	3000	5000
1 standard flat ink	1S	\$2.54	1.84	1.04	0.72	0.62	0.52
2 standard flat inks	1S	\$2.90	2.02	1.19	0.83	0.72	0.57
four color process	4C	\$3.00	2.80	1.55	1.04	0.88	0.83

(R) Prices effective January, 2010

For more information on Smart Art Codes, visit www.smart-artwork.com.

Production time: 5 working days (1 and 2 colors), 10 working days (4 color process)

promotional packaging - large box (price per box)

	smart art code	250	500	1000	2000	3000	5000
1 standard flat ink	1S	\$3.00	2.12	1.73	1.50	1.29	1.14
2 standard flat inks	1S	\$3.52	2.38	1.86	1.55	1.40	1.19
four color process	4C	\$6.78	3.42	2.43	1.76	1.51	1.24

(R) Prices effective January, 2010

For more information on Smart Art Codes, visit www.smart-artwork.com.

Production time: 5 working days (1 and 2 colors), 10 working days (4 color process)

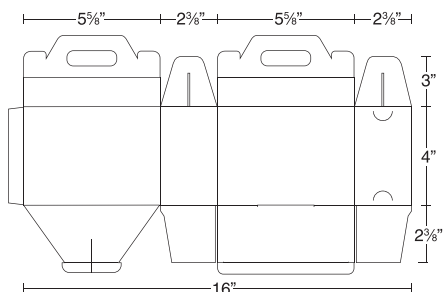

Item Number PROMO-PKGSML

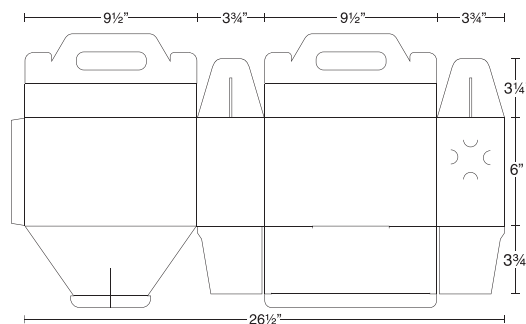

Item Number PROMO-PKGLRG

For quantities not shown, please call for quote.

custom options

we do custom work!

We can create anything you could possibly imagine – the sky is the limit! If you're in need of a certain product not shown in our catalog, call for a quote!



die charges

additional die setup:	\$41.65 (R)
die cutting	
die set-up	\$108.35 (R)
special die cuts first 1000	\$91.75 (R)

Smart Artwork Codes:

For a glossary of terms and codes, visit www.smart-artwork.com.

NATIVE APPLICATIONS

We accept files created in the following native applications:

Acrobat PDF®.....	Mac and PC
QuarkXpress®.....	Mac and PC
Adobe InDesign®.....	Mac and PC
Adobe Photoshop®.....	Mac and PC
Adobe Illustrator®.....	Mac and PC
CorelDRAW®.....	PC only

We do not accept files created in the following native applications:

PowerPoint®.....	Mac and PC
Excel®.....	Mac and PC
Word®.....	Mac and PC
Publisher®.....	Mac and PC

APPLICATION REQUIREMENTS

PDFs — Macintosh or IBM Compatible

- All fonts must be embedded.
- All elements of the file must be colored per our guidelines.
- All placed graphics and images need to be high quality, colored according to our guidelines (at right) for the product ordered. Whenever possible, place vector images into the layout before converting to a PDF. Please be aware that when changes need to be made to placed images (coloring, mode, etc.), there is the possibility of the quality being compromised.
- Please name the PDFs without punctuation of any kind (except .pdf) or special characters. File names should be short.

QuarkXPress® — Macintosh or IBM Compatible

- When selecting fonts, you must use only the selected fonts owned by Navitor®, as listed on Navitor.com. If you are using fonts not owned by Navitor, outlines must be created in an illustration program before placing into your QuarkXPress® document.
- Never use the style palette to modify fonts. It will not hold when printed.
- Along with your file sent for placement, we need the supporting graphic file(s) given the same name as the graphic(s) in your document. (Changing the name after placement will make the graphic come up as "missing" or "modified" when read by our imagesetters.) Place graphics at 100%. Placed graphics need to be high quality or good vector art to receive the best quality printed product.
- Color all text and graphics according to the enclosed color specifications (at right) for the type of product you are ordering.

Adobe® InDesign® — Macintosh or IBM Compatible

- Change all text into "outlines" in your document.
- If you are using an imported graphic in your InDesign® document, be sure to include or embed the original graphic file. Place graphics at 100%. Placed graphics need to be high quality or good vector art to receive the best quality printed product.
- Save as an INDD file.
- Color all text and graphics according to the enclosed color specifications (on reverse) for the type of product you are ordering.

Adobe® Photoshop®

- Files must be saved as a TIFF without compression.
- Do not color an image in Photoshop® (for spot printing).
- Please submit black and white bitmap mode images at 600 dpi and grayscale mode images at 600 dpi for standard spot printing or Multicolor Inks. For full color printed folders, CMYK images need to be submitted at 300 dpi. Images that come to Navitor at a lower quality than what is recommended will be output as sent.
- Color all text and graphics according to the enclosed color specifications (at right) for the type of product you are ordering.
- All files need to be submitted at the size being used for printing.
- If bleeds are needed, allow 1/8" (.125") on all sides.

Adobe® Illustrator® — Macintosh or IBM Compatible

- Change all text into "outlines" in your document.
- If you are using an imported graphic in your Illustrator® document, be sure to include or embed the original graphic file. Place graphics at 100%. Placed graphics need to be high quality or good vector art to receive the best quality printed product.
- Save the file as an Illustrator EPS.
- Color all text and graphics according to the enclosed color specifications (at right) for the type of product you are ordering.

CorelDRAW® — (native files version 12 and lower)

- We do not recommend this application for full color layouts.
- If CorelDraw is used, we cannot guarantee that colors for full color products will match what is seen on screen. You will be responsible for any color issues if native CorelDraw file is sent.
- Follow established guidelines for all graphics. Placed graphics need to be colored correctly for the product ordered (at right). Placed graphics need to be high quality or good vector art to receive the best quality printed product.
- Create outlines (text to curves) on all type within a native CorelDRAW file.
- If there are text overflow issues, Navitor may need to resize or reposition text to fit the imprint area.
- Color all text according to the enclosed color specifications (at right).

CREATING YOUR FILES

Create one item sized correctly per document. (Placed graphics and text should be sized at 100%).

Fonts:

Using your illustration program, convert all text "to curves" or "create outlines" in your files. Never use the stylization palette to bold, italicize, add drop shadow to or put outline on your fonts. If you are using fonts not owned by Navitor, outlines must be created in an illustration program before submitting your artwork.

Margin Requirements:

Spot Color printing (one or more spot colors): artwork must have the position noted in the special instructions, or a sample must be attached. Four color process printing should have at least 1/8" (.125") margins.

Bleed Requirements:

- 1/8" (.125") should be allowed on all sides. Please make sure the text still maintains the required margin even when graphics bleed.

Color Requirements:

Navitor now has a new "Accurate Color" system. To our channel partners - you can now send your files colored the intended PMS color versus having to color it CMYK. Every effort will be made to print your intended color within acceptable standards.

Spot Color Printing:

1. Please submit black and white bitmap mode images at 600 dpi and grayscale mode images at 600 dpi for standard spot printing.

Four Color Process Printing:

1. Every element of the file must be colored with process CMYK colors (no RGB, indexed color, etc.).
2. Pantone® colors - While we are often able to closely reproduce a spot PMS® ink using four color process, PMS® spot colors and process colors are produced using different methods. Therefore, colors produced in four color will differ from Pantone® spot colors, sometimes significantly. Please refer to a Solid to Process Color Imaging Guide for color conversions.

Multicolor Printing:

1. Every element of the file must be colored according to the Multicolor color mix chart (visit Navitor.com) or it may be necessary for us to question the color correctness, which would delay your order.
2. If the CMYK mixes used in your file do not match the Multicolor numbers chosen, we will use the file as is and print as a "CMYK Scan" with no guarantees.

PRINTING BLACK VS. BLACK For Four Color and Multicolor Orders

Use printing black (C-80%, M-80%, Y-80%, K-95%) instead of 100% black when in registration with other colors, in areas with heavy ink coverage, and for bold type or lines (2.5 points or thicker). Use 100% black in all other instances. If the CMYK mixes used in your file do not match the Multicolor numbers chosen, we will use the file as is and print as a "CMYK Scan" with no guarantees.

HOW TO COLOR YOUR FILES FOR SPOT COLOR PRINTING

One Color Imprint:

If ink colors desired are:

Black
Red
Light Blue
Brown
Green
Burgundy
Gray
Dark Blue
Teal
Forest Green
Orange
PMS Ink
Any color not shown
Any foil or embossing

Use these colors:

Black
Red
Light Blue
Brown
Green
Burgundy
Gray
Dark Blue
Teal
Forest Green
Orange
New (see color requirements above)
Black
Conversion (crucial for die ordering)

Two or More Color Imprint:

If ink color desired is:

Black & Light Blue
Dark Blue & Red
Black & Red
Black & Brown
Black & Dark Blue
Light Blue & Red
Black & Burgundy
Any 2 Std. not shown
Black & 1 PMS Ink
2 PMS Inks
1 Standard & 1 PMS
Black & Foil
Black & Embossing

Use this color:

Black & Light Blue
Dark Blue & Red
Black & Red
Black & Brown
Black & Dark Blue
Light Blue & Red
Black & Burgundy
The Actual Color
Color Spot Pantone Colors*
Spot Pantone Colors*
Standard & Spot Pantone Colors*
Black & Conversion
Black & Conversion

* When using a Spot Pantone® Color in your file, it needs to be named and colored the actual Pantone® name and number being used to print your order.

IMPORTANT!

Please indicate your color separations on your order blank.

SUBMITTING YOUR FILES

1. Once your files have been set up according to these guidelines, give them to your business partner to submit to Navitor.
2. We can accept your files on 3.5" floppy disks, 100MB Zip disks, CD-Rs, DVDs, online at Navitor.com, or via e-mail at folderorders@navitor.com.
3. DO NOT send us the only copy of your file. The disk or file could possibly be lost or damaged in the mail. A copy of the original is preferred.
4. We reserve the right to use all products in our advertising and displays unless otherwise specified in writing at the time of the order.

Please visit Navitor.com for further information on submitting files.

Pantone®, PMS and Pantone Matching System® are Pantone Inc.'s check-standard trademark for color reproduction and color reproduction materials.

Folder orders are produced at Navitor Midwest.

general information

art charges: If your layout requires special attention or your artwork is unsuitable for reproduction, we will make the necessary changes. You will be notified if artwork charges apply.

changes or cancellations: Changes to orders in progress may require additional charges and/or time. Cancellations after an order is in progress will require payment for work completed.

die charges: There is an additional charge for a standard 5" envelope slit, 4¼" custom pad slit, standard 2" x 4" size window, flash drive slits or standard file card punch out dies. All other special die cut dies will vary in cost according to the size and amount of detail in your design. Call or send design for a price quote. Allow 5 working days. For orders shipping direct, dies are returned to the dealer at no additional cost.

duotones: Two screened ink colors printed on top of each other.

engraving: This process is available with folders. Call for quote.

FasTurn® folders: **24hr** production example: if order is received Monday by Noon CST, order ships on Tuesday. Prices and production time based on sending print ready artwork. Dies are recycled and not returned. Ink and foil colors are available only as shown. Please indicate style FLDR-FN2 on your order. **Any changes or alterations to FasTurn® features, standard pricing will apply.**

final folding: Orders are shipped with folders open. If folders need to be folded in half when they are shipped, please indicate on order blank.

laminating: Call for pricing and availability. Allow an additional 5 working days.

over/under runs: All presentation folder orders are subject to a 10% over run or under run. No charge for exact quantity. Please indicate on order blank.

proofs: Black and white and color proofs are available. Color proofs may not be exact. Add 2 working days to the production time when requesting a proof. Printed press proofs are billed as actual orders of the minimum quantity less 10%.

rush orders: If production schedule allows, charges for rush orders are based on time constraints and complexity of the order. Contact us for availability and pricing.

third party shipping: Additional charge apply, contact us for pricing.

foil and embossing

die handling: You may provide a blind embossing, die cutting, foil embossing or foil stamping die for re-orders.

die types: Various types of dies are available. See blind embossing, die cutting, foil embossing and foil stamping to determine the appropriate die charge. Foil stamping and embossing dies are not returned.

copper dies: These single level dies are used for foil stamping and blind embossing. Copper dies provide crisp quality without the expense of a brass die.

brass dies: These single or multi-level sculpted dies are used for blind embossing or foil embossing. These dies produce a deep, crisp image with well-defined edges. Note: Fine lines and type do not foil emboss well. Fax or mail artwork for a quote.

foil charges: Special foil colors are available. Call for a quote. If foil area exceeds 36 square inches within two areas, there will be an extra foil charge. Please call for a quote. All foil imprints require the use of a die (see die types).

foil embossing: This is a process that combines foil stamping and embossing into one press run. A brass die is required for this process. Send artwork for a quote.

foil stamping or blind embossing: Orders with one area of foil stamping or blind embossing up to 36 square inches within two areas, there is no additional charge for the die. For orders not within these restrictions, call or send artwork for a quote due to extra foil charges. Charges for dies vary according to the size and amount of detail in your design. We will notify you of any additional costs before processing your order. Send actual sized artwork or a sample for an estimated die charge.

screened foil: The maximum allowed screen is 45% with a minimum of 20%. Screened foil cannot exceed 16 square inches in one area. Imprint width and/or height cannot exceed 6 inches when the screen is a solid area.

additional die set-up: If more than two dies are used, an additional die setup charge and die charge is needed.

four color process

four color process: The pricing for four color process printing includes four process ink colors.

color matching: Industry standard ink densities are used for both PMS® and four color process. If color matching is needed, it must be clarified and approved before production begins.

UV coating: This ultra violet process is available with four color process only.

heavy ink coverage: Any solid or screened areas exceeding 15% of the front or back cover (4"x 4" area) must be flat printed. Any solid areas exceeding 45% (**7" x 7" area**) of the front or back cover will require the heavy ink coverage add on price. In-shop time is 7 days for three or more inks and for two-sided work. Heavy metallic ink not available.

inside copy: Printing inside above pockets requires an extra charge due to the additional press run required. Please refer to the price pages for the applicable charges. Additional production time is also required.

pocket copy: When laying out copy for folder pockets, allow 7/8" additional margin for reinforced edges. Printing ink on folder pockets is not considered inside copy.

ink

screens: A screen is a dot pattern of a solid ink color that makes that color look lighter. For example, when red is screened it looks pink. There is no additional charge for screens. Standard screen percentage is 20%, which will be used unless otherwise indicated. We use 120 line screen. Foil is available screened.

special ink: Special inks are available per color by selecting from the PANTONE® Color Formula Guide. Requesting an exact match from a color swatch or sample will require an additional color match charge.

standard inks: All standard inks are translucent inks. We do not recommend printing ink on dark colored stocks due to the ink discoloring. A no-charge reprint is not available when printing inks on dark colored stocks.

thermography: No additional charge for folders printed in thermography. Legal folders, card carriers, tri-fold folders, Conformer® envelopes, file jackets, vertical pocket folders, multimedia holders, landscape folders, portfolios and style BF8 cannot be printed in thermography. Large imprint areas are not recommended. Thermography cannot register with other processes.

rights to promotion

Navitor® Folders reserves the right to use all products in our advertising and displays unless specified in writing at the time of order.

special charges

additional die setup:	\$41.65 (R)
color match (per color)	\$58.35 (R)
special inks	\$58.35 (R)
die set-up	\$108.35 (R)
special die cuts (first 1000)	\$91.75 (R)
proofs	
electronic or mailed	\$16.65 (R)
color proof (four color only)	\$108.35 (R)
press proof	min. quantity, less 10%

stocks, inks, foils, foil designs

standard cover stocks

class 1 stocks

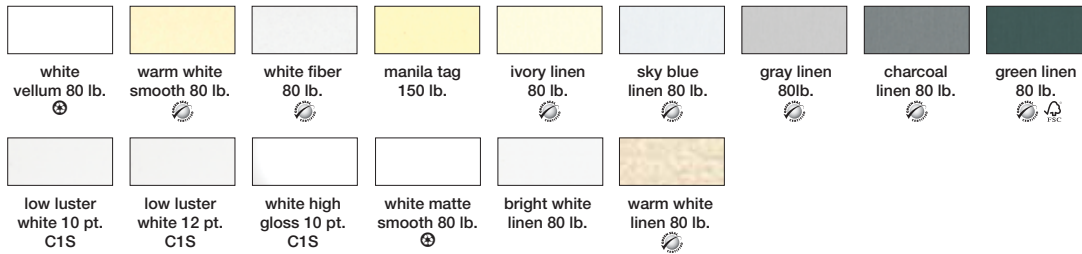

class 2 stocks

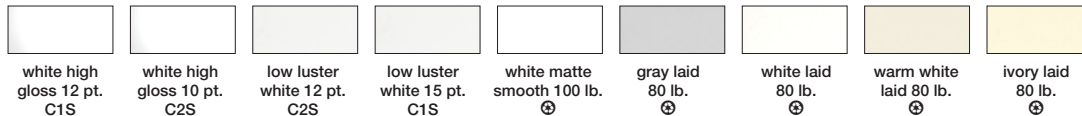

class 3 stocks

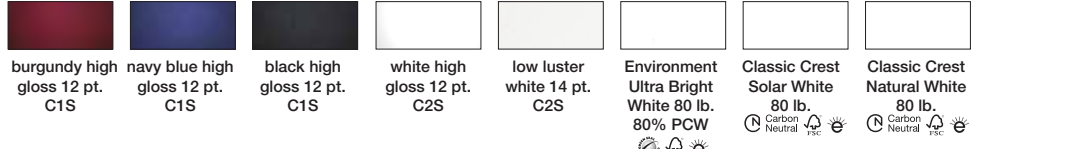

class 4 stocks



environmental code key

Made from energy derived from natural processes that are replenished constantly

Paper originates in an FSC-certified sustainable, well-managed forest

Papers contain at least 30% post-consumer material

Made from a percentage of recycled material

Carbon Neutral
Manufactured using 100% renewable energy

additional stock options (add charges below to base prices)

	50	100	250	500	1000	2000
class 2 stocks	\$40.85	51.80	74.95	100.85	151.15	253.20
class 3 stocks	\$123.05	140.60	180.25	243.90	373.50	628.80
class 4 stocks	\$153.30	176.80	237.60	333.70	513.40	883.65

(R) Prices effective January, 2010

standard ink colors*

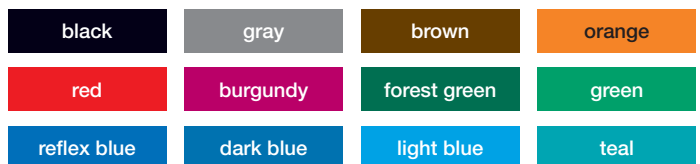

Inks available in flat or raised print.

standard foil colors*

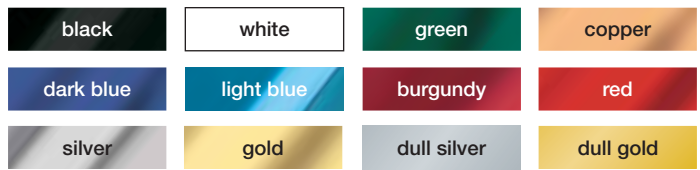

*Colors shown are close representation. Exact color will vary.

For quantities over 2000, please call for quote.

NEW! textured foil designs

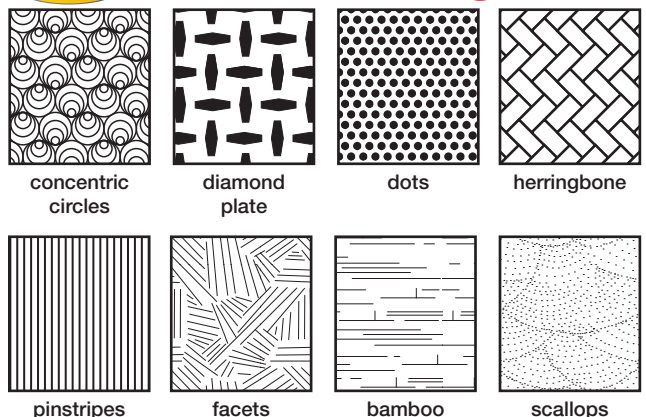

top markets using presentation folders

financial market

Popular Folder Styles:

- Report Covers
- Document Folders
- Expansion Folders
- File Folders

Popular Uses:

- Welcome New Members
- Trust Department Proposals
- Commercial Lending Documents
- 401K Services & Documentation



healthcare

Popular Folder Styles:

- Stepped & Stitched Inserts
- File Folders
- Standard Folders
- Literature Folders

Popular Uses:

- New Patient Welcome Kits
- Pre- and Post-Care Instructions
- Financial & Insurance Paperwork
- In-Room Materials

legal

Popular Folder Styles:

- File Folders
- Standard Folders
- Legal Folders
- Report Covers

Popular Uses:

- Meetings
- Presentations
- Client Portfolios
- Policies & Procedures



real estate

Popular Folder Styles:

- Legal Folders
- Document Folders
- File Folders
- Tri-Fold Folders with Inserts

Popular Uses:

- Apartment Lease Papers
- Home Inspection Reports
- Developer Presentations
- Mortgage Closing Documents

public service

Popular Folder Styles:

- Expansion & Oversized Folders
- Custom & Standard Folders
- File Folders
- Report Covers

Popular Uses:

- Contracts
- Proposals
- Annual Reports
- Confidential Files



folder options

- Over 60 styles
- 50+ stock choices
- Four color process
- Thermography and flat ink
- UV coating
- Laminating
- Foil stamping
- Embossing
- Final folding

folder applications

- Sales presentations
- Tradeshow handouts
- Orientation packets
- Employee benefit packets
- Price listings
- New member packets
- Service listing
- Direct mail packets